



KENAN METAL

ARTINYUM

ZIP SİSTEMLERİ

ZIP SYSTEMS

ZIP SİSTEMLERİ

ZIP SYSTEMS

RTM NYU

Aluminum Profile Systems

ZIP PERDE SİSTEMLERİ, DIŞ MEKANLARDA GÜNEŞ IŞIĞINDAN, SICAKLIKTAN VE HAVA KOŞULLARINDAN KORUNMAK AMACIYLA KULLANILAN MODERN BİR PERDE KAPLAMA ÇÖZÜMÜDÜR.

ALÜMİNYUMDAN YAPILMIŞ BİR KASA, PERDEYİ SAĞLAMAK VE KORUMAK İÇİN KULLANILIR. BU KASA GENELLİKLE ESTETİK VE DAYANIKLILIK AÇISINDAN ÖNEMLİDİR.

ALÜMİNYUM YAN KANALLAR, PERDENİN YANLARDA DÜZGÜN BİR ŞEKİLDE HAREKET ETMESİNİ SAĞLAR VE RÜZGARIN ALTINA SIZMASINI ÖNLER.

ZIP BLIND SYSTEMS ARE A MODERN WINDOW COVERING SOLUTION USED TO PROTECT OUTDOOR SPACES FROM SUNLIGHT, HEAT, AND WEATHER CONDITIONS.

A CASING MADE OF ALUMINUM IS USED TO STORE AND PROTECT THE BLIND. THIS CASING IS GENERALLY IMPORTANT FOR AESTHETICS AND DURABILITY.

ALUMINUM SIDE CHANNELS ENSURE THE SMOOTH MOVEMENT OF THE BLIND ON THE SIDES AND PREVENT WIND FROM SEEPING UNDERNEATH.



Outdoor Of Art
Diş Mekanda Sanat

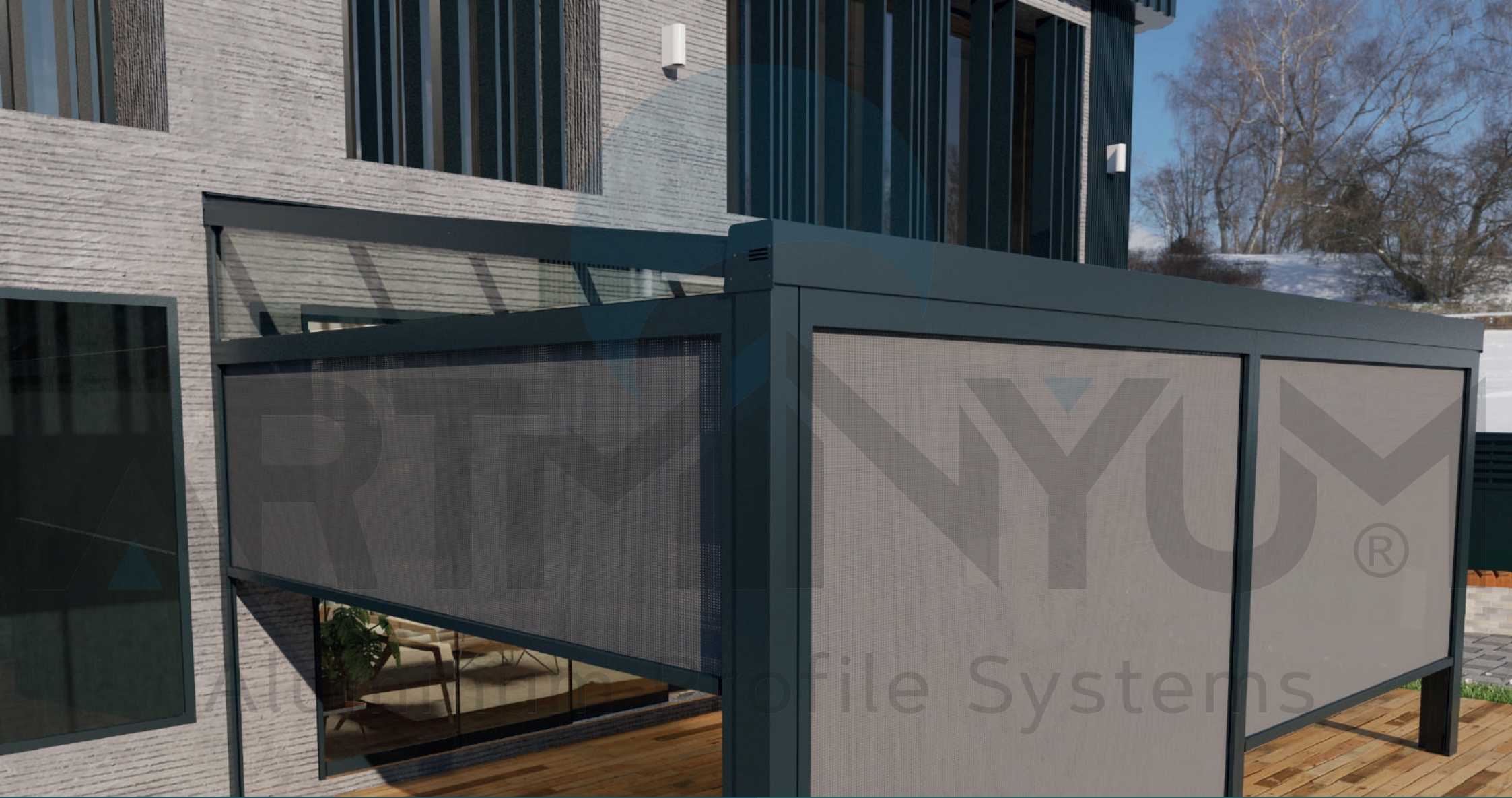

RAL RENK STANDARĐINA GÖRE SEÇTİĐİNİZ TÜM RENKLER UYGULANABİLİR.

COLOURING OF YOUR CHOICE, ACCORDING TO THE RAL COLOUR STANDARD.



YAĐMUR VE RÜZGAR GİBİ HAVA ŞARTLARINA SON DERECE DAYANIKLIDIR.

IT IS EXTREMELY RESISTANT TO WEATHER CONDITIONS SUCH AS RAIN AND WIND.



MATERYAL // 6063 T5 ALÜMİNYUM, PASLANMAZ ÇELİK VE DERLİN.

MATERIALS // 6063 T5 ALUMINUM, STAINLESS STEEL AND DERLIN.

- ZIP PERDE SİSTEMLERİ, PERDE MALZEMESİNİN YAN KENARLARINA ENTEGRE EDİLMİŞ ÖZEL BİR FERMUAR SİSTEMİ KULLANIR. BU, PERDENİN YAN KANALLARDA DAHA GÜVENLİ BİR ŞEKİLDE TUTULMASINI SAĐLAR VE RÜZGAR GEÇİŞİNİ EN AZA İNDİRİR.

- ALÜMİNYUM ZIP PERDE SİSTEMLERİ, DAYANIKLILIK, ESTETİK VE İŞLEVSELLİĐİ BİR ARAYA GETİREN BİR ÇÖZÜM SUNAR VE DİŐ MEKANLARDA KONFORLU BİR ORTAM OLUŐTURMAK İÇİN KULLANILIR.

- DİŐ MEKAN OTURMA ALANLARINI RÜZGAR, GÜNEŐ VE YAĐMURDAN KORUMAK AMACIYLA RESTORAN VE KAFE GİBİ TİCARİ MEKANLARDA TERCİH EDİLİR.

- ZIP BLIND SYSTEMS USE A SPECIAL ZIPPER SYSTEM INTEGRATED INTO THE SIDE EDGES OF THE BLIND MATERIAL. THIS ENSURES THAT THE BLIND IS HELD MORE SECURELY IN THE SIDE CHANNELS AND MINIMIZES THE PASSAGE OF WIND.

- ALUMINUM ZIP BLIND SYSTEMS OFFER A SOLUTION THAT COMBINES DURABILITY, AESTHETICS, AND FUNCTIONALITY, AND THEY ARE USED TO CREATE A COMFORTABLE ENVIRONMENT IN OUTDOOR SPACES.

- THEY ARE PREFERRED IN COMMERCIAL SETTINGS SUCH AS RESTAURANTS AND CAFES TO PROTECT OUTDOOR SEATING AREAS FROM WIND, SUN, AND RAIN.



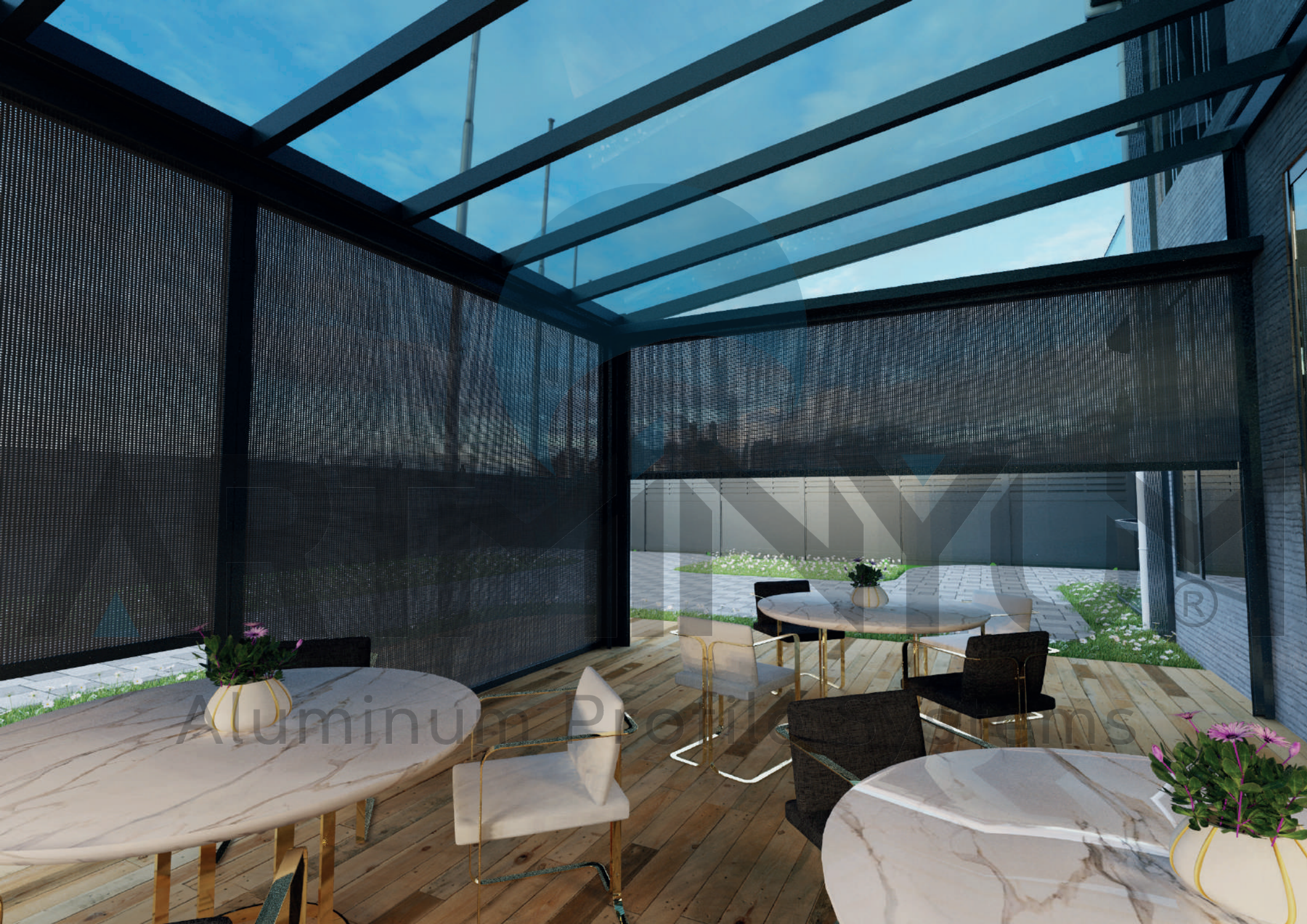

Aluminum Profiles

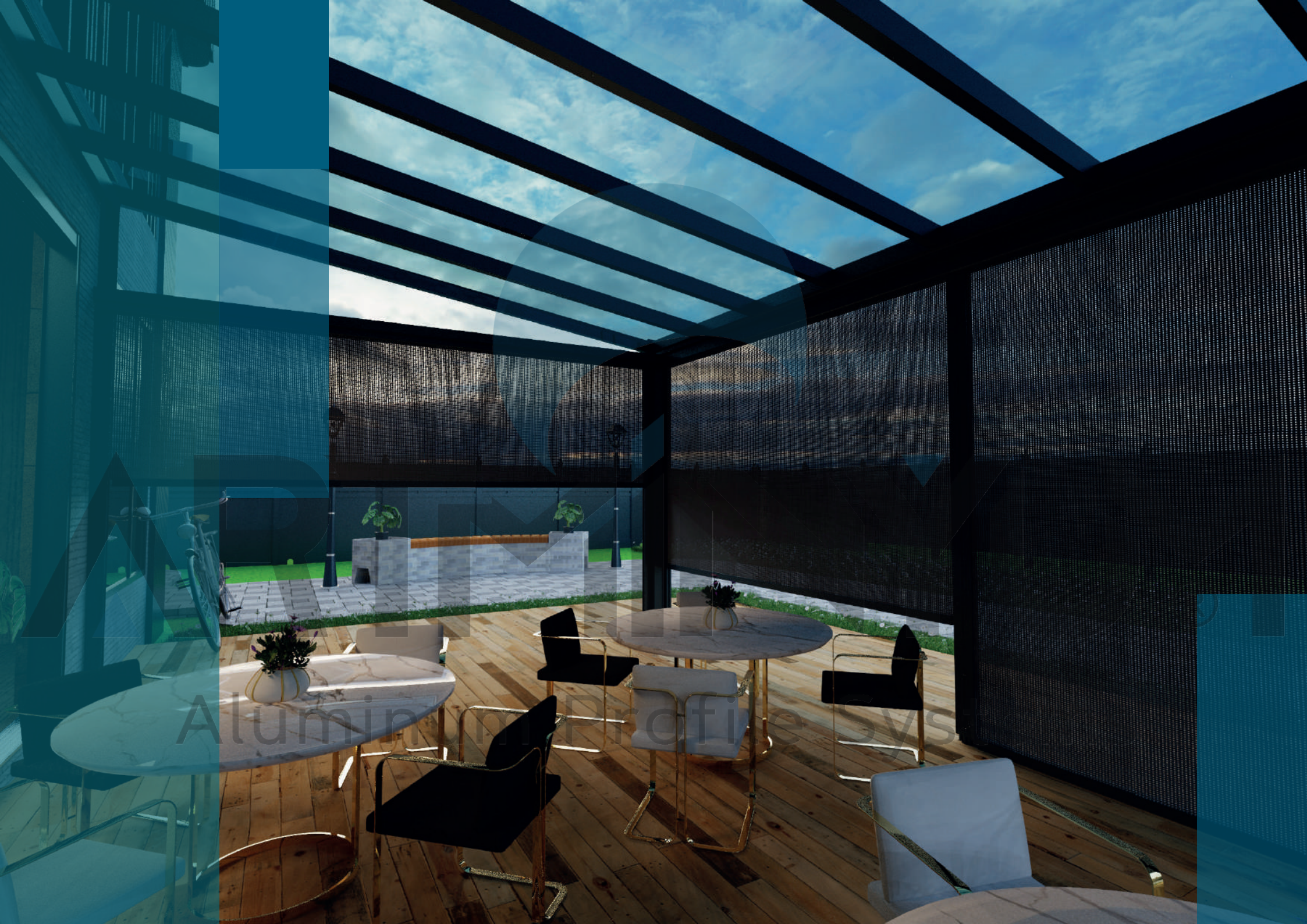

MAX 3000 mm

MAX 4000 mm

Artminyum®
Alu Profile Systems



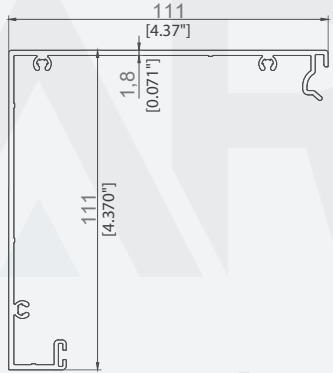

MOTOR KUTUSU PROFİLİ
MOTOR BOX PROFILE

ÜRÜN KODU / PRODUCT CODE	2878
AĞIRLIK / WEIGHT	1,450 KG/M 3,197 LB/M

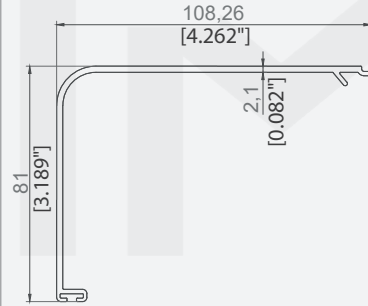
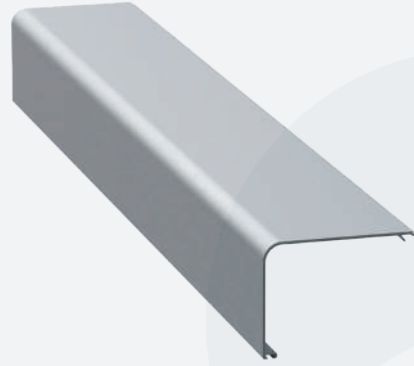

MOTOR KUTUSU KAPAĞI PROFİLİ
MOTOR BOX COVER PROFILE

ÜRÜN KODU / PRODUCT CODE	2875
AĞIRLIK / WEIGHT	1,102 KG/M 2,430 LB/M

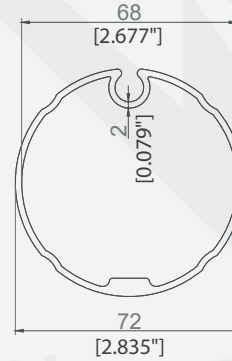

70lik BORU / 70MM PIPE

ÜRÜN KODU / PRODUCT CODE	3830
AĞIRLIK / WEIGHT	1,436 KG/M 3,166 LB/M

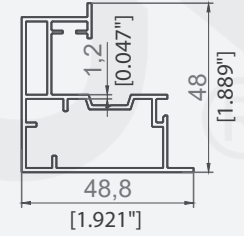

RAY PROFİLİ / RAIL PROFILE

ÜRÜN KODU / PRODUCT CODE	2877
AĞIRLIK / WEIGHT	0,726 KG/M 1,601 LB/M

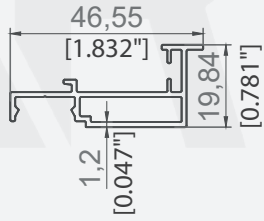

RAY KAPAĞI PROFİLİ / RAIL COVER PROFILE

ÜRÜN KODU / PRODUCT CODE	2874
AĞIRLIK / WEIGHT	0,382 KG/M 0,842 LB/M

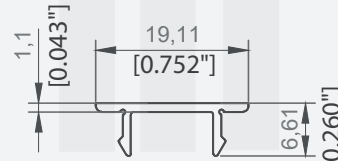
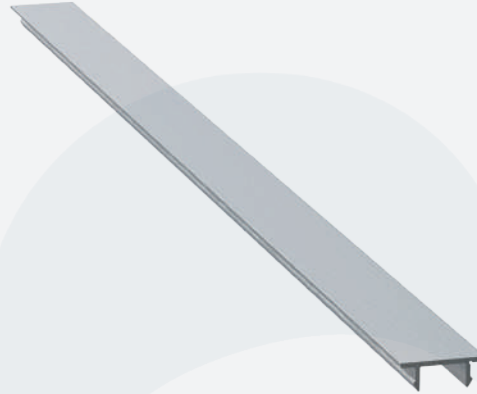
RAY VİDA KAPAĞI /
RAIL SCREW COVER

ÜRÜN KODU / PRODUCT CODE	2876
AĞIRLIK / WEIGHT	0,084 KG/M 0,185 LB/M

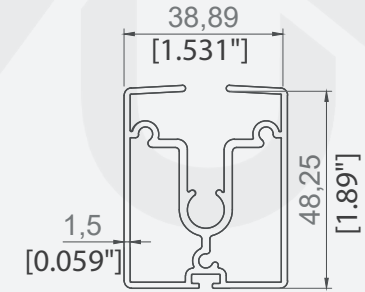
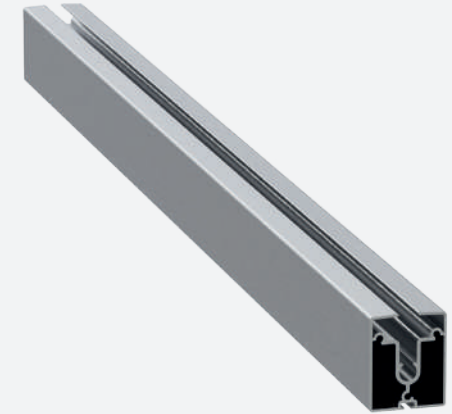

KUMAŞ ALT PROFİLİ / FABRIC BOTTOM PROFILE













ÜRÜN KODU / PRODUCT CODE	2937
AĞIRLIK / WEIGHT	1,201 KG/M 2,647 LB/M

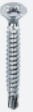
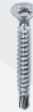

ZİP PERDE AKSESUAR SETİ

ZIP CURTAIN ACCESSORY SET

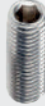
KOD/CODE: ZIP-01

 <p>MOTOR KUTUSU SAĞ KAPAK MOTOR BOX RIGHT COVER</p> <p>KOD / CODE ADET / PIECE</p> <p>1</p>	 <p>MOTOR KUTUSU SOL KAPAK MOTOR BOX LEFT COVER</p> <p>KOD / CODE ADET / PIECE</p> <p>1</p>	 <p>MOTOR KUTUSU KAPAK APARATI MOTOR BOX COVER APPARATUS</p> <p>KOD / CODE ADET / PIECE</p> <p>2</p>	 <p>AĞIRLIK PROFİLİ ÇITASI WEIGHT PROFILE LATH</p> <p>KOD / CODE ADET / PIECE</p> <p>2</p>	 <p>AĞIRLIK PROFİLİ KAPAĞI WEIGHT PROFILE COVER</p> <p>KOD / CODE ADET / PIECE</p> <p>2</p>
 <p>YAN DİKME PROFİL KAPAĞI SIDE STRUT PROFILE COVER</p> <p>KOD / CODE ADET / PIECE</p> <p>2</p>	 <p>RULMAN YATAĞI PLASTİĞİ BEARING HOUSING PLASTIC</p> <p>KOD / CODE ADET / PIECE</p> <p>1</p>	 <p>MOTOR BAŞI VE MOTOR SWITCH PLASTİĞİ MOTOR HEAD AND MOTOR SWITCH PLASTIC</p> <p>KOD / CODE ADET / PIECE</p> <p>2</p>	 <p>6301 RULMAN 6301 RULMAN</p> <p>KOD / CODE ADET / PIECE</p> <p>1</p>	
 <p>3,9X19 YHB VİDA 3,9X19 YHB SCREW</p> <p>KOD / CODE ADET / PIECE</p> <p>30</p>	 <p>3,9X30 YHB VİDA 3,9X30 YHB SCREW</p> <p>KOD / CODE ADET / PIECE</p> <p>2</p>	 <p>M4 SOMUN M4 NUT</p> <p>KOD / CODE ADET / PIECE</p> <p>2</p>	 <p>M6X8 SETSKUR VİDA M6X8 SETSKUR SCREW</p> <p>KOD / CODE ADET / PIECE</p> <p>4</p>	 <p>M4X8 H.B. YILDIZ BAŞLI İNOX M4X8 H.B. STAR HEADED İNOX</p> <p>KOD / CODE ADET / PIECE</p> <p>2</p>

Aluminum Profile Systems



ZIP PERDE FERMUAR
ZIP CURTAIN ZIPPER

KOD / CODE
ADET / PIECE

ZIP-02



6MM PVC ÇUBUK
6MM PVC ROD

KOD / CODE
ADET / PIECE

ZIP-03



DIKME KUEKSİZ FİTİL
SEWING QUENCHED ROVING

KOD / CODE
ADET / PIECE

ZIP-04



DIKME BALONLU CONTASI
STRUT BALLOON GASKET

KOD / CODE
ADET / PIECE

ZIP-05



MOTOR KUTUSU CONTASI
MOTOR BOX GASKET

KOD / CODE
ADET / PIECE

GYT-28



6,7X800 KIL FİTİL
6,7X800 BRISTLE WICK

KOD / CODE
ADET / PIECE

GYT-29



70LİK GALVANİZ BORU
70 GALVANIZED PIPE

KOD / CODE
ADET / PIECE

ZIP-07



SOMFY RTS 40 NM
SOMFY RTS 40 NM

KOD / CODE
ADET / PIECE

RTS-40



SOMFY RTS 20 NM
SOMFY RTS 20 NM

RTS-20



SOMFY ZIP PERDE MOTOR APARATI
SOMFY ZIP CURTAIN MOTOR APPARATUS

KOD / CODE
ADET / PIECE

ZIP-06



ZIP PERDE AKSESUARLARI

ZIP CURTAIN ACCESSORIES



UNIVERSAL ZIP PERDE MOTOR APARATI
UNIVERSAL ZIP CURTAIN MOTOR APPARATUS

KOD / CODE
ADET / PIECE

ZIP-08



ZIP SCREEN KUMAŞ KREM (30DN202)
ZIP SCREEN FABRIC CREAM (30DN202)

KOD / CODE
ADET / PIECE

ZIP-K01

1 ROLL

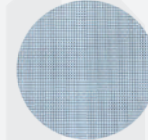

ZIP SCREEN KUMAŞ GRİ (30ADN303)
ZIP SCREEN FABRIC GREY (30ADN303)

KOD / CODE
ADET / PIECE

ZIP-K02

1 ROLL

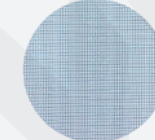

ZIP SCREEN KUMAŞ BEYAZ (30DN001)
ZIP SCREEN FABRIC WHITE (30DN001)

KOD / CODE
ADET / PIECE

ZIP-K03

1 ROLL

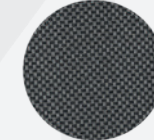

ZIP SCREEN KUMAŞ CHARCOAL-DARK GREY (30ADN906)
ZIP SCREEN FABRIC CHARCOAL-DARK GREY (30ADN906)

KOD / CODE
ADET / PIECE

ZIP-K04

1 ROLL



ZIP SCREEN KUMAŞ CHARCOAL-CHARCOAL (30ADN914)
ZIP SCREEN FABRIC CHARCOAL-CHARCOAL (30ADN914)

KOD / CODE
ADET / PIECE

ZIP-K05

1 ROLL

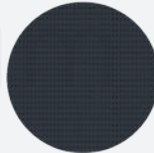

ZIP PERDE SERGE FERRARI KUMAŞ ANT. GRİ (SOLTİS 86)
ZIP SCREEN SERGE FERRARI FABRIC ANTHRACITE (SOLTİS 86)

KOD / CODE
ADET / PIECE

ZIP-FK01

1 ROLL

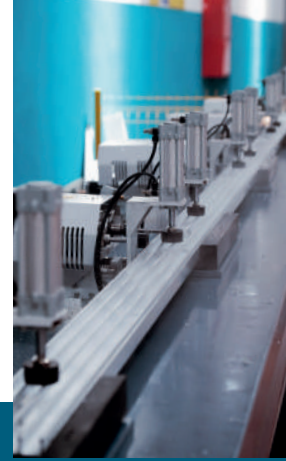
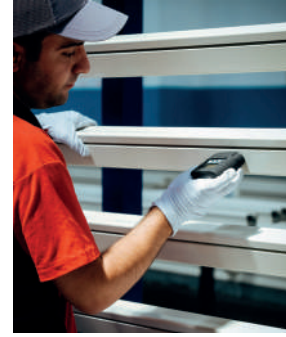
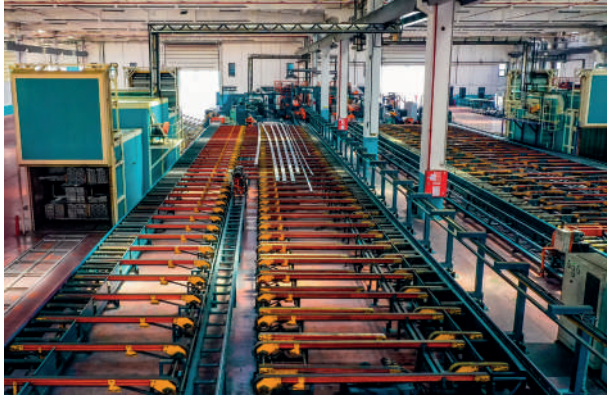

Biz kimiz ?

ÜSTÜN KALİTELİ ALÜMİNYUM PROFİL ÜRETİMİNİ HER GEÇEN GÜN ARTAN STANDARTLARLA DEVAM ETTİREN KENAN METAL A.Ş. ÜLKEMİZİN ÖNDE GELEN ALÜMİNYUM FABRİKALARINDAN BİRİDİR. MUTLAK MÜŞTERİ VE ÇALIŞAN MEMNUNİYETİ PRENSİBİYLE ÜRETİM YAPAN KENAN METAL A.Ş., TENTE PERGOLA, İNŞAAT VE ÖZEL PROFİLLER GİBİ FARKLI SEKTÖRLERİN MEVCUT VE GELECEKTEKİ BEKLENTİLERİNİ KARŞILAYAN, ÇEVREYLE DOST ÜRETİM SİSTEMLERİNİ BENİMSEYEN, KÜRESEL ETKİLEŞİMLERİ YAKINDAN TAKİP EDEREK SÜREKLİ YENİLENEN, ÇAĞDAŞ BİR VİZYONLA GELİŞİYOR. ÜRÜN-KALİTE ÇİTASININ SÜREKLİ YÜKSEKİLMESİ, ÜRÜN YELPAZESİNİN GELİŞTİRİLMESİ, YENİ ÜRÜNLERİN TASARIMI, KULLANIM ALANLARININ ARTTIRILMASI İÇİN SÜREKLİ OLARAK ÇALIŞAN AR-GE BÖLÜMÜYLE GÖZ DOLDURAN KENAN METAL A.Ş., KALİTESİ GÜVENİLİRLİĞİ, KULLANDIĞI TEKNOLOJİ VE ÖZEL ÇÖZÜMLER ÜRETME GÜCÜYLE PAZAR PAYINI SÜREKLİ GENİŞLETİYOR.

KENAN METAL A.Ş., ALÜMİNYUM BAZLI ÜRÜNLERİN KALİTELERİNİ ARTTIRARAK VE KULLANIM ALANLARINI YAYGINLAŞTIRARAK DOĞAL VE ESTETİK MEKANLARIN YARATILMASINA DA ÖNCÜLÜK EDİYOR. HER YAPI İÇİN KENDİNE ÖZGÜ ÜSTÜN NİTELİKLİ VE İLERİ TEKNOLOJİ GEREKTİREN ÇAĞDAŞ ÇÖZÜMLER SUNAN KENAN METAL A.Ş., ESNEK YAKLAŞIMLARI ÜSTÜN HİZMET KALİTESİ VE FİYAT-KALİTE DENGESİYLE KÜRESEL PAZARDA SÖZ SAHİBİ BİR KURUM OLMA YOLUNDA EMİN ADIMLARLA İLERLİYOR.

WHO ARE WE?

KENAN METAL IS ONE OF THE LEADING ALUMINUM FACTORIES OF OUR COUNTRY WHICH CONTINUES TO PRODUCE HIGH QUALITY ALUMINUM PROFILES WITH INCREASING STANDARDS EACH PASSING DAY. KENAN METAL WHICH MAKES PRODUCTION WITH ABSOLUTE CUSTOMER AND EMPLOYEE SATISFACTION PRINCIPLE, DEVELOPS WITH A MEDERN VISION THAT MEETS CURRENT AND FUTURE EXPECTATIONS OF DIFFERENT SECTORS SUCH AS AWNING PERGOLA, CONSTRUCTION AND SPECIAL PROFILES, ADOPTS ENVIRONMENTALLY FRIENDLY PRODUCTION SYSTEMS, RENEWS ITSELF CONSTANTLY BY FOLLOWING GLOBAL INTERACTIONS CLOSELY.

KENAN METAL WHICH MAKES A STRONG IMPRESSION WITH ITS R&D DEPARTMENT WORKING CON STANTLY FOR RAISING PRODUCT-QUALITY LEVEL, IMPROVING PRODUCT RANGE, DESIGNING NEW PRODUCTS, INCREASING USAGE AREAS, EXPANDS ITS MARKET SHARE CONSTANTLY WITH ITS QUALITY, CREDIBILITY TECHNOLOGY USED AND POWER TO PRODUCE SPECIAL SOLUTIONS KENAN METAL IS ALSO LEADING CREATION OF NATURAL AND AESTHETIC SPACES BY INCREASING QUALITY OF ALUMINUM-BASED PRODUCTS AND EXPANDING USAGE AREAS. KENAN METAL WHICH OFFERS ITS UNIQUE, SUPERIOR AND MODERN SOLUTIONS REQUIRING ADVANCED TECHNOLOGY FOR EVERY STRUCTURE, IS MOVING CONFIDENTLY ON ITS WAY TO BECAME A PROMISING COMPANY IN GLOBAL MARKET WITH ITS FLEXIBLE APPROACHES, SUPERIOR SERVICE QUALITY AND PRICE-QUALITY BALANCE.



KENAN METAL®





KENANMETAL.COM | INFO@KENANMETAL.COM | +90 212 485 60 35

GENEL MERKEZ : İOSB MH. ATATÜRK BLV. MAHMUT TORUN İŞ MERKEZİ NO: 54 KAT:1 34490 İKİTELLİ OSB / BAŞAKŞEHİR / İSTANBUL
FABRİKA : VELİMEŞE MAHALLESİ, KANDİL CADDESİ, 329 SOKAK, DIŞ KAPI NO:7 ERGENE / TEKİRDAĞ

