



KENAN METAL



ARTINYUM

ZIP SİSTEMLERİ

ZIP SYSTEMS

ZIP SİSTEMLERİ

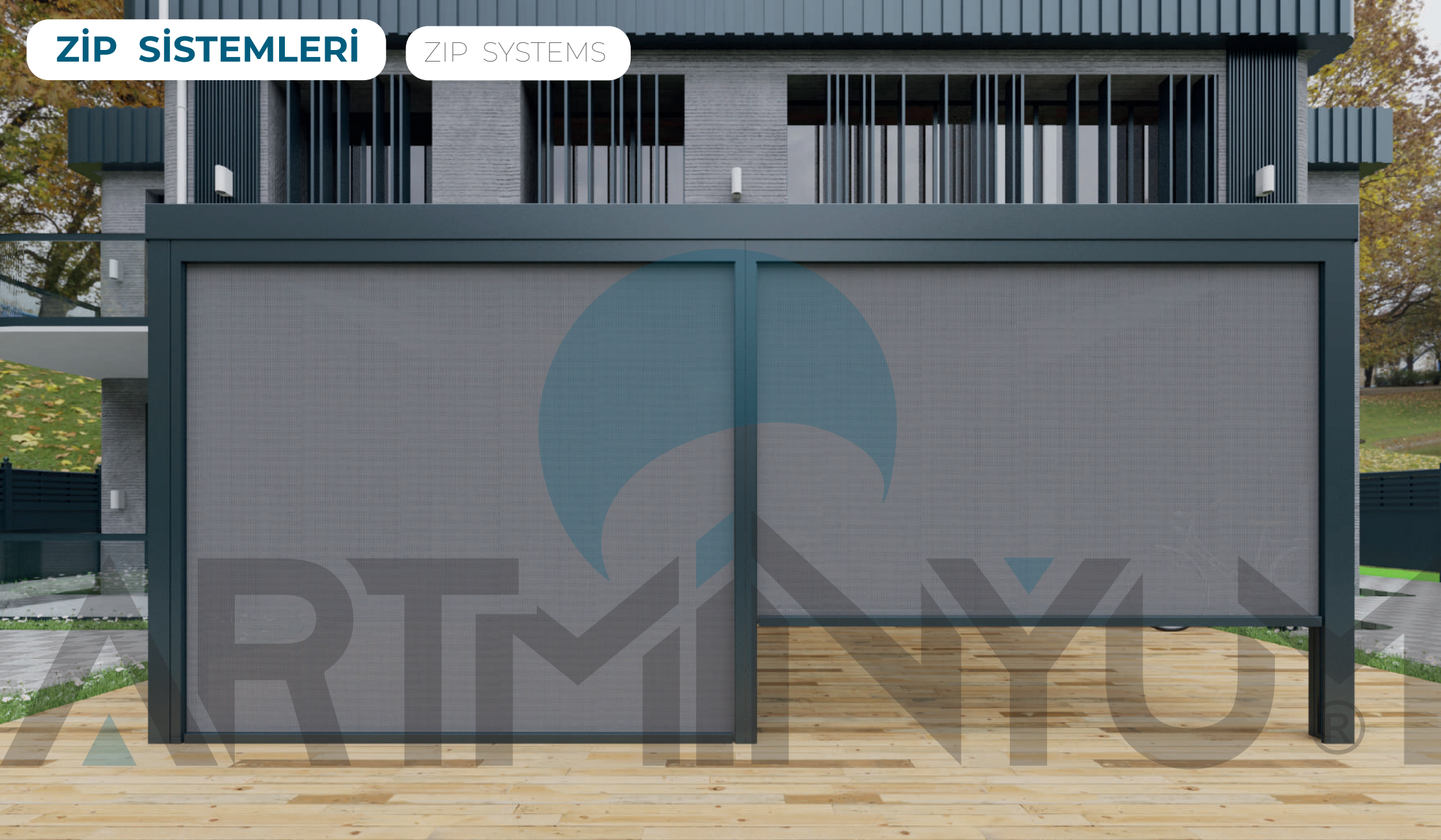
ZIP SYSTEMS



ZIP PERDE SİSTEMLERİ, DIŞ MEKANLARDA GÜNEŞ IŞIĞINDAN, SICAKLIKTAN VE HAVA KOŞULLARINDAN KORUNMAK AMACIYLA KULLANILAN MODERN BİR PERDE KAPLAMA ÇÖZÜMÜDÜR.

ALÜMİNYUMDAN YAPILMIŞ BİR KASA, PERDEYİ SAĞLAMAK VE KORUMAK İÇİN KULLANILIR. BU KASA GENELLİKLE ESTETİK VE DAYANIKLILIK AÇISINDAN ÖNEMLİDİR.

ALÜMİNYUM YAN KANALLAR, PERDENİN YANLARDA DÜZGÜN BİR ŞEKİLDE HAREKET ETMESİNİ SAĞLAR VE RÜZGARIN ALTINA SIZMASINI ÖNLER.

ZIP BLIND SYSTEMS ARE A MODERN WINDOW COVERING SOLUTION USED TO PROTECT OUTDOOR SPACES FROM SUNLIGHT, HEAT, AND WEATHER CONDITIONS.

A CASING MADE OF ALUMINUM IS USED TO STORE AND PROTECT THE BLIND. THIS CASING IS GENERALLY IMPORTANT FOR AESTHETICS AND DURABILITY.

ALUMINUM SIDE CHANNELS ENSURE THE SMOOTH MOVEMENT OF THE BLIND ON THE SIDES AND PREVENT WIND FROM SEEPING UNDERNEATH.



Outdoor Of Art
Dış Mekanda Sanat

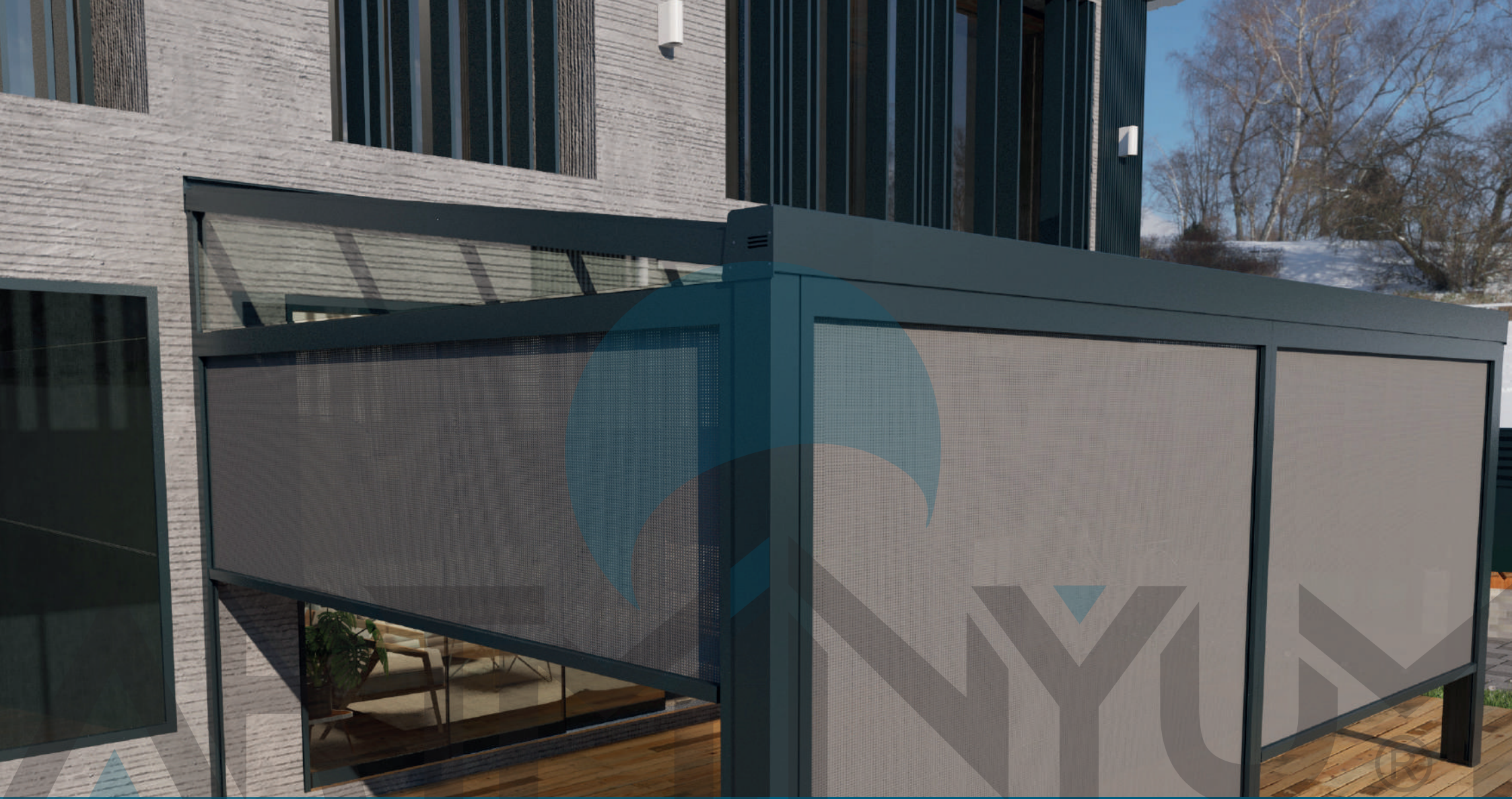

RAL RENK STANDARĐINA GÖRE SEÇTİĐİNİZ TÜM RENKLER UYGULANABİLİR.

COLOURING OF YOUR CHOICE, ACCORDING TO THE RAL COLOUR STANDARD.



YAĐMUR VE RÜZGAR GİBİ HAVA ŞARTLARINA SON DERECE DAYANIKLIDIR.

IT IS EXTREMELY RESISTANT TO WEATHER CONDITIONS SUCH AS RAIN AND WIND.



MATERYAL // 6063 T5 ALÜMİNYUM, PASLANMAZ ÇELİK VE DERLİN.

MATERIALS // 6063 T5 ALUMINUM, STAINLESS STEEL AND DERLIN.

ZIP PERDE SİSTEMLERİ, PERDE MALZEMESİNİN YAN KENARLARINA ENTEGRE EDİLMİŞ ÖZEL BİR FERMUAR SİSTEMİ KULLANIR. BU, PERDENİN YAN KANALLARDA DAHA GÜVENLİ BİR ŞEKİLDE TUTULMASINI SAĐLAR VE RÜZGAR GEÇİŞİNİ EN AZA İNDİRİR.

ALÜMİNYUM ZIP PERDE SİSTEMLERİ, DAYANIKLILIK, ESTETİK VE İŞLEVSELLİĐİ BİR ARAYA GETİREN BİR ÇÖZÜM SUNAR VE DİŐ MEKANLARDA KONFORLU BİR ORTAM OLUŐTURMAK İÇİN KULLANILIR.

DİŐ MEKAN OTURMA ALANLARINI RÜZGAR, GÜNEŐ VE YAĐMURDAN KORUMAK AMACIYLA RESTORAN VE KAFE GİBİ TİCARİ MEKANLARDA TERCİH EDİLİR.

ZIP BLIND SYSTEMS USE A SPECIAL ZIPPER SYSTEM INTEGRATED INTO THE SIDE EDGES OF THE BLIND MATERIAL. THIS ENSURES THAT THE BLIND IS HELD MORE SECURELY IN THE SIDE CHANNELS AND MINIMIZES THE PASSAGE OF WIND.

ALUMINUM ZIP BLIND SYSTEMS OFFER A SOLUTION THAT COMBINES DURABILITY, AESTHETICS, AND FUNCTIONALITY, AND THEY ARE USED TO CREATE A COMFORTABLE ENVIRONMENT IN OUTDOOR SPACES.

THEY ARE PREFERRED IN COMMERCIAL SETTINGS SUCH AS RESTAURANTS AND CAFES TO PROTECT OUTDOOR SEATING AREAS FROM WIND, SUN, AND RAIN.



ARTMINYUM
Aluminum Profile Systems





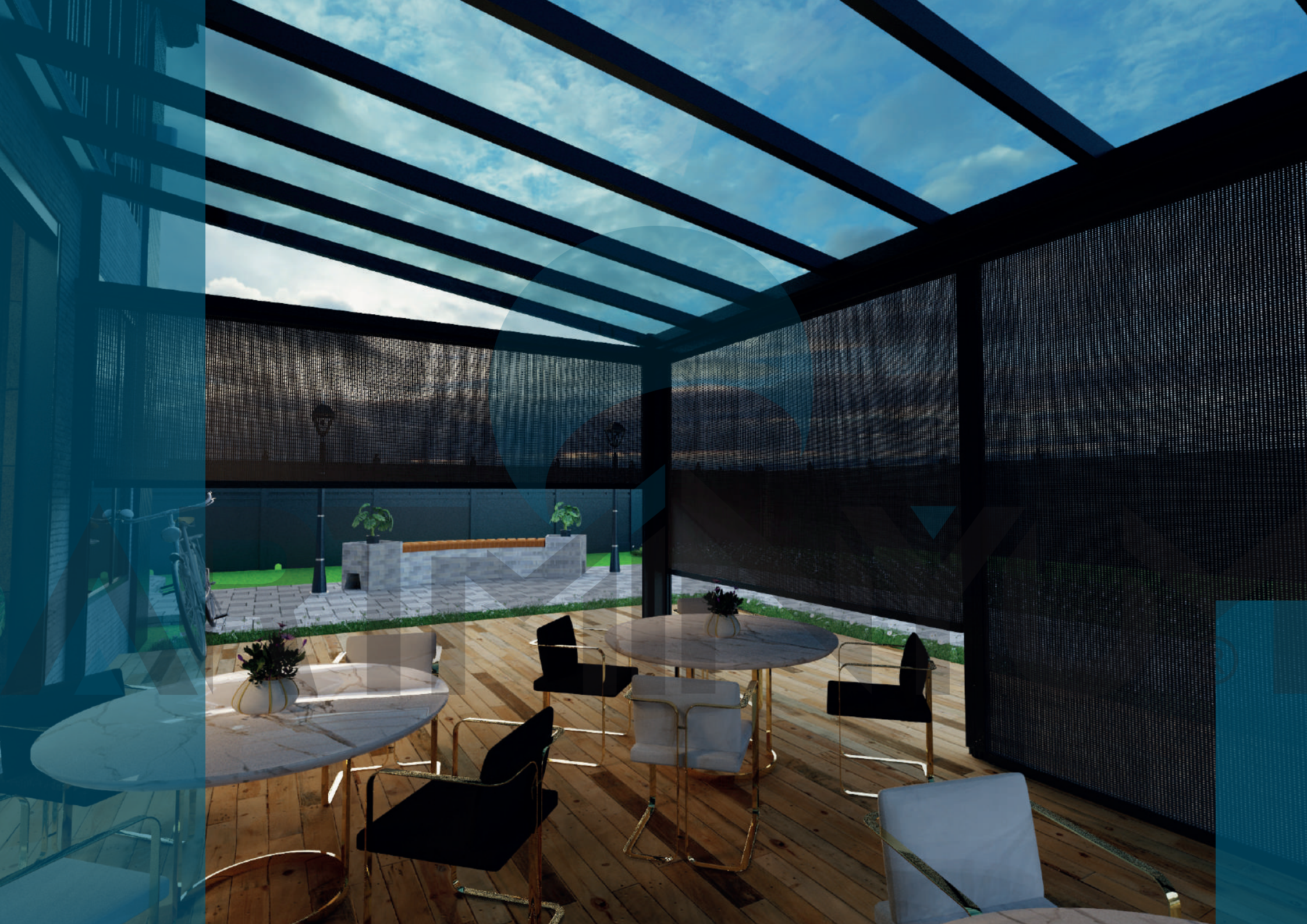

MAX 3000 mm

MAX 4000 mm





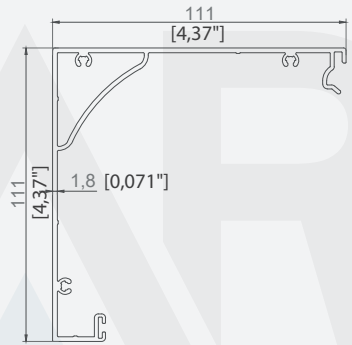

MOTOR KUTUSU PROFİLİ
MOTOR BOX PROFILE

ÜRÜN KODU / PRODUCT CODE	2878
AĞIRLIK / WEIGHT	1,683 KG/M 3,710 LB/M

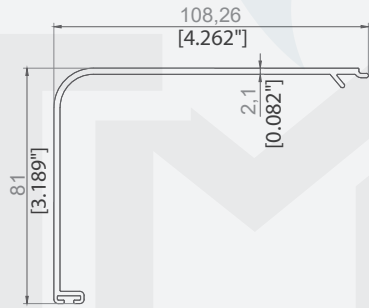
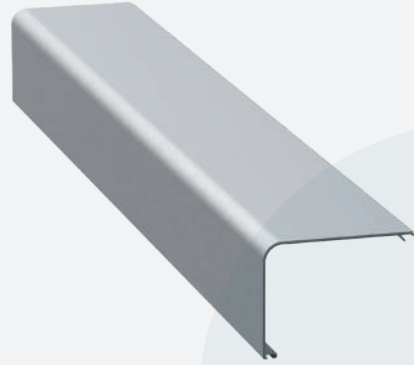

MOTOR KUTUSU KAPAĞI PROFİLİ
MOTOR BOX COVER PROFILE

ÜRÜN KODU / PRODUCT CODE	2875
AĞIRLIK / WEIGHT	1,102 KG/M 2,430 LB/M

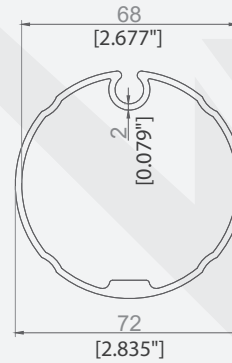

70lik BORU / 70MM PIPE

ÜRÜN KODU / PRODUCT CODE	3830
AĞIRLIK / WEIGHT	1,436 KG/M 3,166 LB/M

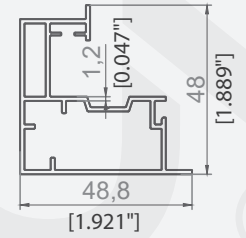

RAY PROFİLİ / RAIL PROFILE

ÜRÜN KODU / PRODUCT CODE	2877
AĞIRLIK / WEIGHT	0,726 KG/M 1,601 LB/M

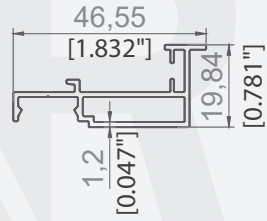

RAY KAPAĞI PROFİLİ / RAIL COVER PROFILE

ÜRÜN KODU / PRODUCT CODE	2874
AĞIRLIK / WEIGHT	0,382 KG/M 0,842 LB/M

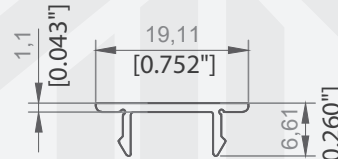
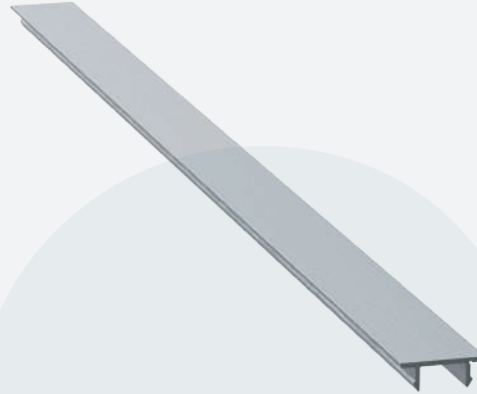
RAY VİDA KAPAĞI /
RAIL SCREW COVER

ÜRÜN KODU / PRODUCT CODE	2876
AĞIRLIK / WEIGHT	0,084 KG/M 0,185 LB/M

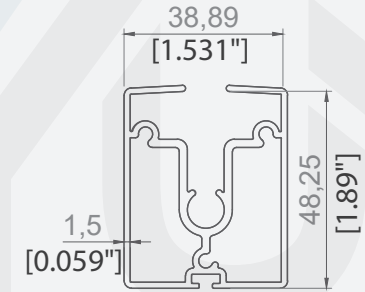
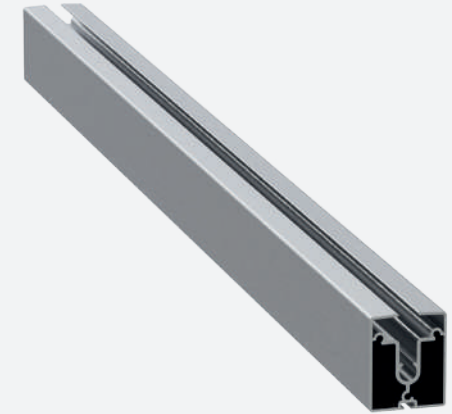

KUMAŞ ALT PROFİLİ / FABRIC BOTTOM PROFILE















ÜRÜN KODU / PRODUCT CODE	2937
AĞIRLIK / WEIGHT	1,201 KG/M 2,647 LB/M

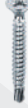

ZİP PERDE AKSESUAR SETİ

ZIP CURTAIN ACCESSORY SET

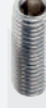
KOD/CODE:ZİP-01

 <p>MOTOR KUTUSU SAĞ KAPAK MOTOR BOX,RIGHT COVER</p> <p>KOD / CODE ADET / PIECE</p> <p>1</p>	 <p>MOTOR KUTUSU SOL KAPAK MOTOR BOX LEFT COVER</p> <p>KOD / CODE ADET / PIECE</p> <p>1</p>	 <p>MOTOR KUTUSU KAPAK APARATU MOTOR BOX COVER APPARATUS</p> <p>KOD / CODE ADET / PIECE</p> <p>2</p>	 <p>AĞIRLIK PROFİLİ ÇİTASI WEIGHT PROFILE LATH</p> <p>KOD / CODE ADET / PIECE</p> <p>2</p>	 <p>AĞIRLIK PROFİLİ KAPAĞI WEIGHT PROFILE COVER</p> <p>KOD / CODE ADET / PIECE</p> <p>2</p>
 <p>YAN DİKME PROFİL KAPAĞI SIDE STRUT PROFILE COVER</p> <p>KOD / CODE ADET / PIECE</p> <p>2</p>	 <p>RULMAN YATAĞI PLASTİĞİ BEARING HOUSING PLASTIC</p> <p>KOD / CODE ADET / PIECE</p> <p>1</p>	 <p>MOTOR BAŞI VE MOTOR SWITCH PLASTİĞİ MOTOR HEAD AND MOTOR SWITCH PLASTIC</p> <p>KOD / CODE ADET / PIECE</p> <p>2</p>	 <p>6301 RULMAN 6301 RULMAN</p> <p>KOD / CODE ADET / PIECE</p> <p>1</p>	
 <p>3,9X19 YHB VİDA 3,9X19 YHB SCREW</p> <p>KOD / CODE ADET / PIECE</p> <p>30</p>	 <p>3,9X30 YHB VİDA 3,9X30 YHB SCREW</p> <p>KOD / CODE ADET / PIECE</p> <p>2</p>	 <p>M4 SOMUN M4 NUT</p> <p>KOD / CODE ADET / PIECE</p> <p>2</p>	 <p>M6X8 SETSKUR VİDA M6X8 SETSKUR SCREW</p> <p>KOD / CODE ADET / PIECE</p> <p>4</p>	 <p>M4X8 H.B. YILDIZ BAŞLI İNOX M4X8 H.B. STAR HEADED İNOX</p> <p>KOD / CODE ADET / PIECE</p> <p>2</p>



ZIP PERDE FERMUAR
ZIP CURTAIN ZIPPER

KOD / CODE
ADET / PIECE

ZIP-02



6MM PVC ÇUBUK
6MM PVC ROD

KOD / CODE
ADET / PIECE

ZIP-03



DIKME KUEKSİZ FİTİL
SEWING QUENCHED ROVING

KOD / CODE
ADET / PIECE

ZIP-04



DIKME BALONLU CONTASI
STRUT BALLOON GASKET

KOD / CODE
ADET / PIECE

ZIP-05



MOTOR KUTUSU CONTASI
MOTOR BOX GASKET

KOD / CODE
ADET / PIECE

GYT-28



6,7X800 KIL FİTİL
6,7X800 BRISTLE WICK

KOD / CODE
ADET / PIECE

GYT-29



70LİK GALVANİZ BORU
70 GALVANIZED PIPE

KOD / CODE
ADET / PIECE

ZIP-07



SOMFY RTS 40 NM
SOMFY RTS 40 NM

KOD / CODE
ADET / PIECE

RTS-40



SOMFY RTS 20 NM
SOMFY RTS 20 NM

KOD / CODE
ADET / PIECE

RTS-20



SOMFY ZIP PERDE MOTOR APARATI
SOMFY ZIP CURTAIN MOTOR APPARATUS

KOD / CODE
ADET / PIECE

ZIP-06



UNIVERSAL ZIP PERDE MOTOR APARATI
UNIVERSAL ZIP CURTAIN MOTOR APPARATUS

KOD / CODE
ADET / PIECE

ZIP-08

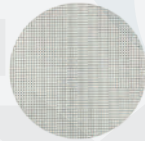

ZIP SCREEN KUMAŞ KREM (30DN202)
ZIP SCREEN FABRIC CREAM (30DN202)

KOD / CODE
ADET / PIECE

ZIP-K01

1 ROLL

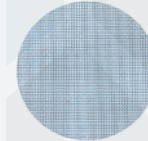

ZIP SCREEN KUMAŞ GRİ (30ADN303)
ZIP SCREEN FABRIC GREY (30ADN303)

KOD / CODE
ADET / PIECE

ZIP-K02

1 ROLL



ZIP SCREEN KUMAŞ BEYAZ (30DN001)
ZIP SCREEN FABRIC WHITE (30DN001)

KOD / CODE
ADET / PIECE

ZIP-K03

1 ROLL

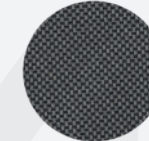

ZIP SCREEN KUMAŞ CHARCOAL-DARK GREY (30ADN906)
ZIP SCREEN FABRIC CHARCOAL-DARK GREY (30ADN906)

KOD / CODE
ADET / PIECE

ZIP-K04

1 ROLL



ZIP SCREEN KUMAŞ CHARCOAL-CHARCOAL (30ADN914)
ZIP SCREEN FABRIC CHARCOAL-CHARCOAL (30ADN914)

KOD / CODE
ADET / PIECE

ZIP-K05

1 ROLL

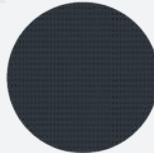

ZIP PERDE SERGE FERRARI KUMAŞ ANT. GRİ (SOLTIS 86)
ZIP SCREEN SERGE FERRARI FABRIC ANTHRACITE (SOLTIS 86)

KOD / CODE
ADET / PIECE

ZIP-FK01

1 ROLL



ZIP PERDE AKSESUARLARI

ZIP CURTAIN ACCESSORIES

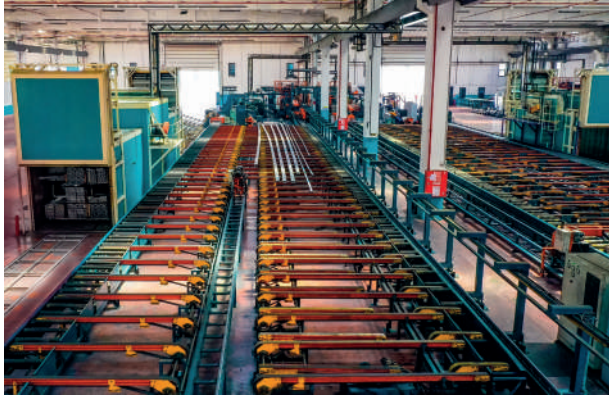

Biz Kimiz ?

Üstün kaliteli alüminyum profil üretimini her geçen gün artan standartlarla devam ettiren Kenan Metal A.Ş. ülkemizin önde gelen alüminyum fabrikalarından biridir. Mutlak müşteri ve çalışan memnuniyeti prensibiyle üretim yapan Kenan Metal A.Ş., tente pergola, inşaat ve özel profiller gibi farklı sektörlerin mevcut ve gelecekteki beklentilerini karşılayan, çevreyle dost üretim sistemlerini benimseyen, küresel etkileşimleri yakından takip ederek sürekli yenilenen, çağdaş bir vizyonla gelişiyor. Ürün-kalite çitasının sürekli yükselmesi , ürün yelpazesinin geliştirilmesi, yeni ürünlerin tasarımı, kullanım alanlarının artırılması için sürekli olarak çalışan Ar-Ge bölümüyle göz dolduran Kenan Metal A.Ş., kalitesi güvenilirliği, kullandığı teknoloji ve özel çözümler üretme gücüyle pazar payını sürekli genişletiyor.

Kenan Metal A.Ş., alüminyum bazlı ürünlerin kalitelerini arttırarak ve kullanım alalarını yaygınlaştırarak doğal ve estetik mekanların yaratılmasına da öncülük ediyor. Her yapı için kendine özgü üstün nitelikli ve ileri teknoloji gerektiren çağdaş çözümler sunan Kenan Metal A.Ş., esnek yaklaşımları üstün hizmet kalitesi ve fiyat-kalite dengesiyle küresel pazarda söz sahibi bir kurum olma yolunda emin adımlarla ilerliyor.

Who Are We?

Kenan Metal is one of the leading aluminum factories of our country which continues to produce high quality aluminum profiles with increasing standards each passing day. Kenan Metal which makes production with absolute customer and employee satisfaction principle, develops with a modern vision that meets current and future expectations of different sectors such as awning pergola, construction and special profiles, adopts environmentally friendly production systems, renews itself constantly by following global interactions closely.

Kenan Metal which makes a strong impression with its R&D department working constantly for raising product-quality level, improving product range, designing new products, increasing usage areas, expands its market share constantly with its quality, credibility technology used and power to produce special solutions

Kenan Metal is also leading creation of natural and aesthetic spaces by increasing quality of aluminum-based products and expanding usage areas. Kenan Metal which offers its unique, superior and modern solutions requiring advanced technology for every structure, is moving confidently on its way to become a promising company in global market with its flexible approaches, superior service quality and price-quality balance.



KENAN METAL®





kenanmetal.com | info@kenanmetal.com | +90 212 485 60 35

Genel Merkez : İosb Mh. Atatürk Blv. Mahmut Torun İş Merkezi No: 54 Kat: 1 34490 İkitelli Osb / Başakşehir / İstanbul
Fabrika : Velimeşe Mahallesi, Kandil Caddesi, 329 Sokak, Dış Kapı No:7 Ergene / Tekirdağ

