

KENAN METAL

ARTINYUM



PENDORA ISICAMLI SÜRME CAM SİSTEMLERİ

Pendora Insulated Glass
Sliding Glass Systems

PENDORA CAM SİSTEMLERİ

Pendora Glass Systems



Pendora Isıcamlı Sürme Cam Sistemleri, iç ve dış arasındaki hava boşluğu sayesinde daha iyi bir ısı yalıtımı sağlar. Bu, iç mekanın sıcaklığını korurken dış mekanın etkilerini azaltır ve enerji tasarrufu sağlar.

Pendora Isıcamlı Sürme Cam Sistemleri, sadece ısı geçişini değil aynı zamanda ses geçişini de azaltır. Bu, iç mekanda daha sessiz bir ortam sağlar.

Pendora Isıcamlı Sürme Cam Sistemleri, modern ve şık bir görünüm sunar. 2'li , 3'lü , 4'lü , 5'li , 6'lı , 7'li ve 8'li varyasyonları bulunduğu için her ortamda tercih edilebilir.

Isıcam, iç mekanı daha rahat ve konforlu hale getirir. Sıcaklık dalgalanmalarını düzenler.

Pendora Insulated Sliding Glass Systems provide better thermal insulation thanks to the air gap between the interior and exterior. This helps maintain the temperature inside while reducing the effects of the external environment and saving energy.

Pendora Insulated Sliding Glass Systems not only reduce heat transfer but also minimize sound transmission, creating a quieter indoor environment.

Pendora Insulated Sliding Glass Systems offer a modern and stylish appearance. They come in 2-panel, 3-panel, 4-panel, 5-panel, 6-panel, 7-panel, and 8-panel variations, making them suitable for any space.

Insulated glass makes the interior more comfortable and cozy, regulating temperature fluctuations.



ARTMINYUM[®]
Aluminum Profile Systems

Outdoor of Art
Diş Yaşamda Sanat



RAL renk standardına göre seçtiğiniz tüm renkler uygulanabilir.

Coloring of your choice, according to the RAL color standard.



Yağmur ve rüzgar gibi hava şartlarına son derece dayanıklıdır.

It is extremely resistant to weather conditions such as rain and wind.



Materyal // 6063 T5 alüminyum, paslanmaz çelik ve delrin.

Materials // 6063 T5 aluminum, stainless steel and delrin.

- Pendora Isıcamlı Sürme Cam Sistemleri, evler, restoranlar ve kış bahçeleri gibi mekanlarda tercih edebileceğiniz bir çözümdür. Isıcamlı sürme serisi, camların ısı cam özelliğine sahip ve çift taraflı temperli olması nedeniyle daha etkili bir yalıtım, güvenlik ve dolayısıyla enerji tasarrufu sağlar.

- Bu sistem, dört mevsim boyunca daha konforlu ve yalıtımlı bir ortamda yaşamınızı kolaylaştırır. Isıcamın içerisinde temperli camlar, hem güvenlik hem de kırılmaya karşı önlem olarak kullanılmaktadır.

- Bu ürünün maksimum yüksekliği 3 metre, maksimum genişliği ise 10 metredir. Bu özelliklerle Pendora Isıcamlı Sürme Cam Sistemleri, mekanlarınızı daha güvenli ve konforlu hale getirmenize yardımcı olabilir.

- "Pendora Insulated Sliding Glass Systems can be preferred in homes, restaurants, and winter gardens. In the insulated sliding series, the fact that the glasses are insulated and double-sided tempered provides more effective insulation, security, and, therefore, energy savings.

- It makes it easier to live in more comfortable and insulated spaces in all four seasons. As a security measure and to prevent breakage, tempered safety glass should be used within the insulated glass. The maximum height of the product is 3 meters, and the maximum width is 10 meters.

- With these features, Pendora Insulated Sliding Glass Systems can help make your spaces safer and more comfortable."



Aluminum Profile Systems



**ARTMINYUM**[®]
Aluminum Profile Systems



Aluminum Profile Systems

Artmimum



Aluminium Profile Systems

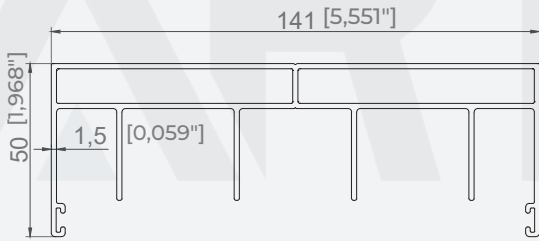
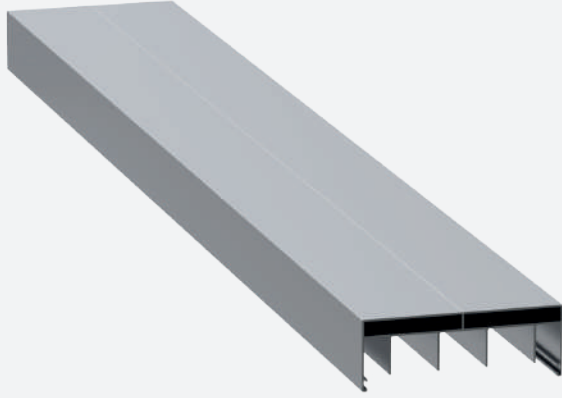

Üst Ray Profili / Top Rail Profile

Ürün Kodu / Product Code	2069
Ağırlık / Weight	2,054 kg/m 4,528 lb/m

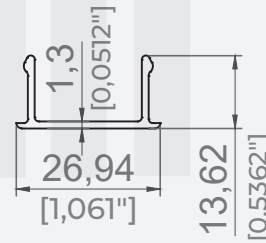
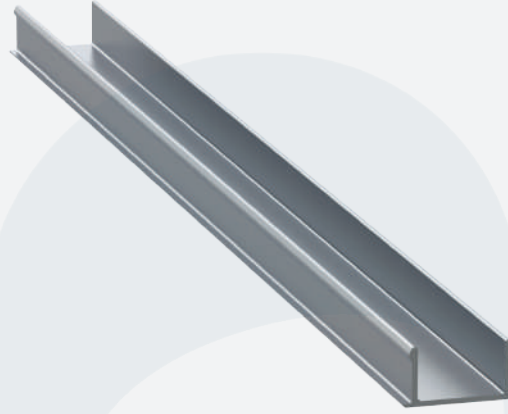

Yan Ray Profili Kapağı / Side Rail Cover Profile

Ürün Kodu / Product Code	2067
Ağırlık / Weight	0,186 kg/m 0,410 lb/m

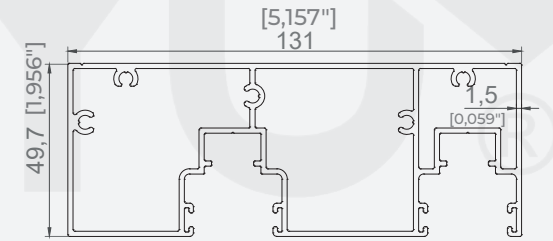

Yan Ray Profili / Side Rail Profile

Ürün Kodu / Product Code	2066
Ağırlık / Weight	2,414 kg/m 5,322 lb/m

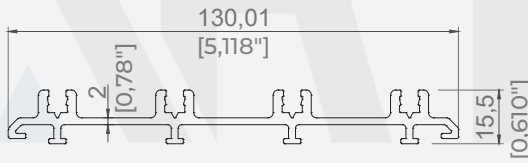

Alt Kasa Profili / Bottom Case Profile

Ürün Kodu / Product Code	2070
Ağırlık / Weight	1,480 kg/m 3,263 lb/m

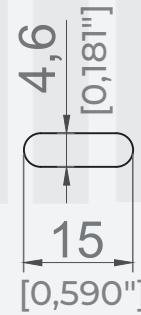

Alt Ray Teker Profili / Bottom Rail Wheel Profile

Ürün Kodu / Product Code	2117
Ağırlık / Weight	0,185 kg/m 0,408 lb/m

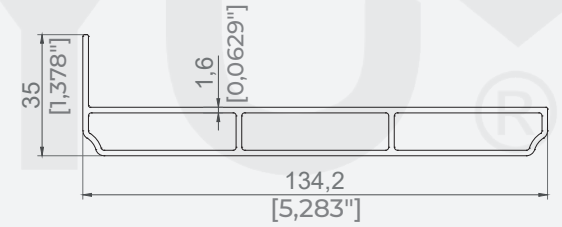

Baza Profili / Sill Profile

Ürün Kodu / Product Code	2566
Ağırlık / Weight	1,423 kg/m 3,137 lb/m

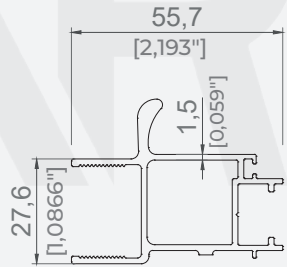

60x17,2 Cam Kapak Profili / 60x17,2 Glass Cover Profile

Ürün Kodu / Product Code	2068
Ağırlık / Weight	0,878 kg/m 1,936 lb/m

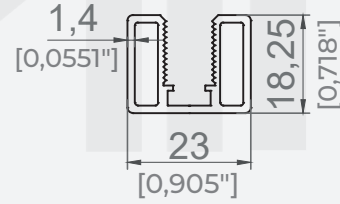

8mm Cam Adaptör Profili / 8mm Glass Adapter Profile

Ürün Kodu / Product Code	2150
Ağırlık / Weight	0,375 kg/m 0,827 lb/m

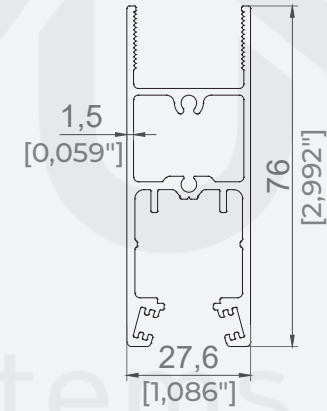
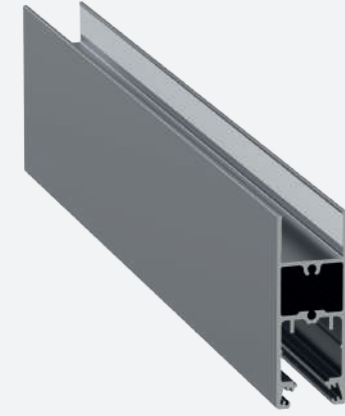
22mm Cam Panel Alt Profili /
22mm Glass Panel Bottom Profile

Ürün Kodu / Product Code	2565
Ağırlık / Weight	1,205 kg/m 2,657 lb/m

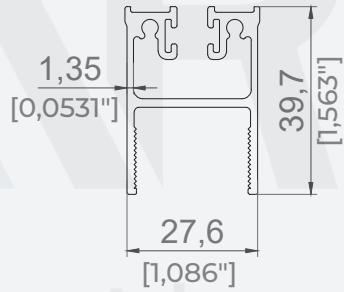

22 mm Cam Panel Üst Profili /
22 mm Glass Panel Top Profile

Ürün Kodu / Product Code	2071
Ağırlık / Weight	0,703 kg/m 1,550 lb/m

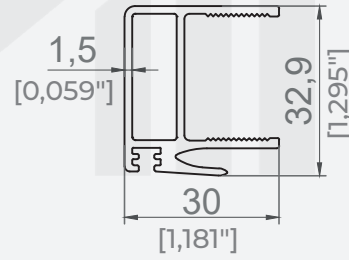

62,2x32,3 Kenar Cam Kapak Profili /
62,2x32,3 Side Glass Cover Profile

Ürün Kodu / Product Code	2065
Ağırlık / Weight	0,585 kg/m 1,290 lb/m

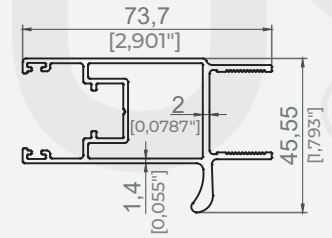

Orta Kanat Birleştirme Profili / Middle Panel Side Profile

Ürün Kodu / Product Code	2149
Ağırlık / Weight	1,160 kg/m 2,557 lb/m



Sağ Sürme Seti
Kod: Srm-01

Sliding Set Right
Code: Srm-01

							
Kasa Alt Köşe Takozu Case Lower Corner Wedge	Kasa Üst Köşe Takozu Case Top Corner Wedge	Sürme Teker Çiftli Alt Sliding Wheel Double Bottom	Kollu Kanat Üst Plastik Arm Wing Top Plastic	Kollu Kanat Alt Plastik Arm Wing Lower Plastic	Tırnaklı Kanat Üst Plastik Spiked Wing Top Plastic	Sürme Üst Teker Sliding Upper Wheel	Tırnaklı Kanat Alt Plastik Spiked Wing Lower Plastic
Kod / Code	Srm-01	Kod / Code	Srm-07	Kod / Code	Srm-01	Kod / Code	Srm-11
Adet / Piece	2	Adet / Piece	2	Adet / Piece	2	Adet / Piece	16



Sol Sürme Seti
Kod: Srm-02

Sliding Set Left
Code: Srm-02

							
Kasa Alt Köşe Takozu Case Lower Corner Wedge	Kasa Üst Köşe Takozu Case Top Corner Wedge	Sürme Teker Çiftli Alt Sliding Wheel Double Bottom	Kollu Kanat Üst Plastik Arm Wing Top Plastic	Kollu Kanat Alt Plastik Arm Wing Lower Plastic	Tırnaklı Kanat Üst Plastik Spiked Wing Top Plastic	Sürme Üst Teker Sliding Upper Wheel	Tırnaklı Kanat Alt Plastik Spiked Wing Lower Plastic
Kod / Code	Srm-02	Kod / Code	Srm-07	Kod / Code	Srm-02	Kod / Code	Srm-11
Adet / Piece	2	Adet / Piece	2	Adet / Piece	2	Adet / Piece	16



Sürme Cam Sistemi
Aksesuarları

Sliding Glass
Accessories

					
İspanyolet Espagnolette	İspanyolet Karşılığı Espagnolett Equivalent	Kilitli Kol (Yerli) Unlocked Handle	Kilitli Kol (Yerli) Locked Handle	Kilitli Kol (Roto) Unlocked Handle	Kilitli Kol (Roto) Locked Handle
Kod / Code	Srm-03	Kod / Code	Srm-04	Kod / Code	Srm-12
Adet / Piece	2	Adet / Piece	6	Adet / Piece	1

			
Sürme Orta Birleşim Plastik Sliding mid-joint plastic	EPDM Contra EPDM Bolt	6.7x550 Kıl Fitili 6.7x550 Brush	4.8x500 Kıl Fitili 4.8x450 Brush
Kod / Code	Srm-17	Kod / Code	Srm-14
Adet / Piece	1	Rulo / Roll	375 Meters
		Adet / Piece	1500 Meters
		Kod / Code	Srm-15
		Adet / Piece	550 Meters
			2200 Meters

Aluminum Profile Systems

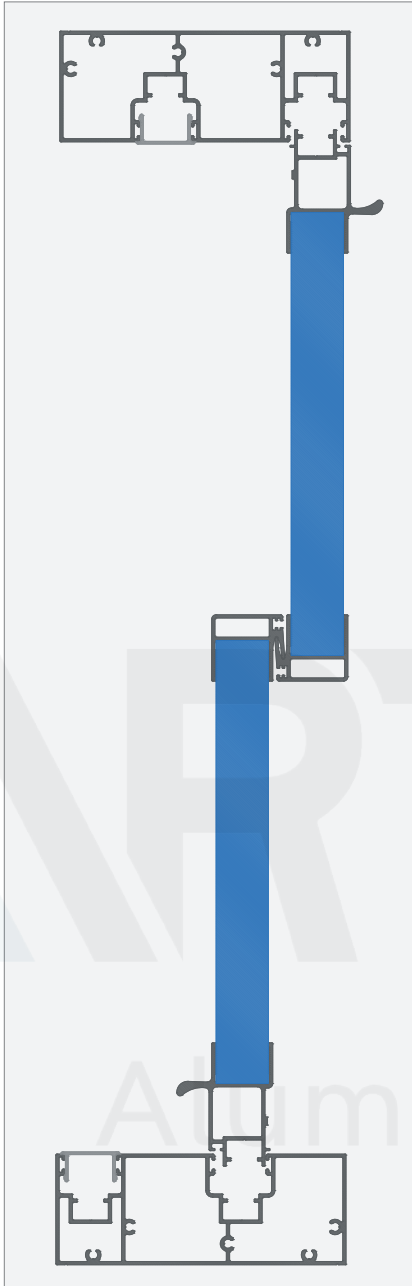

İkili Sistem
Double System

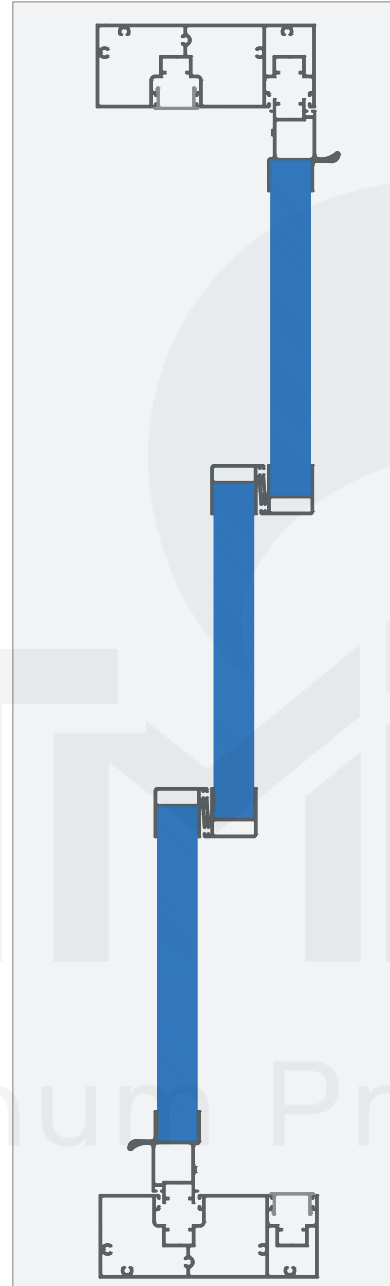

Üçlü Sistem
Triple System

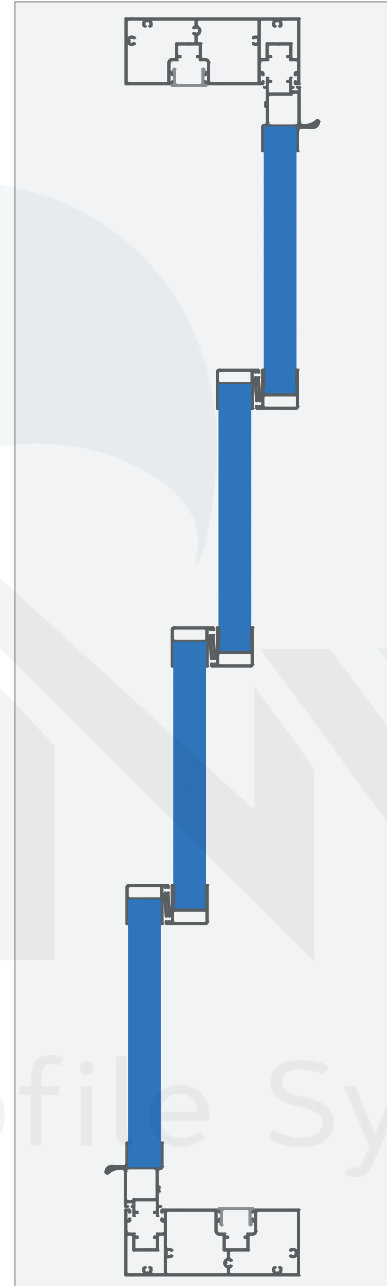

Dörtlü Sistem
Quadruple System

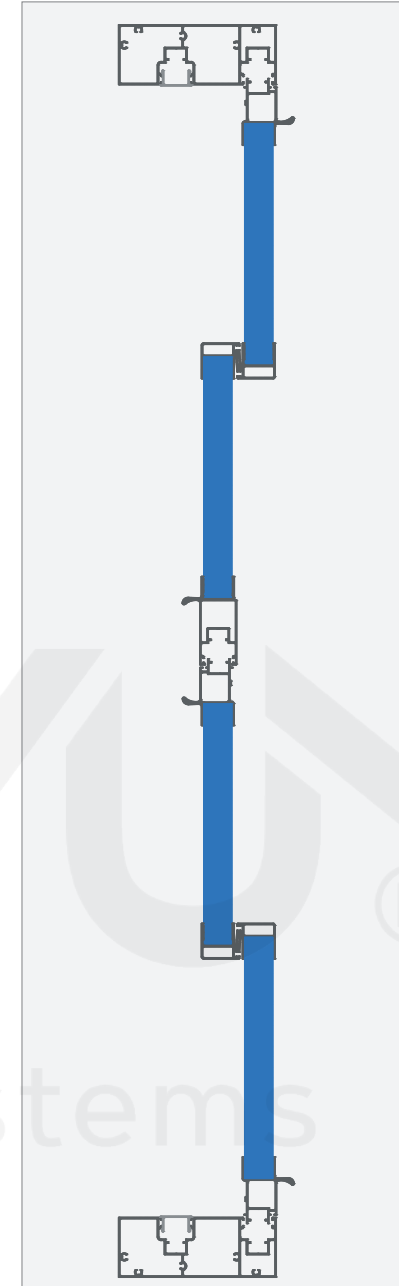

Dörtlü Sistem
Quadruple System

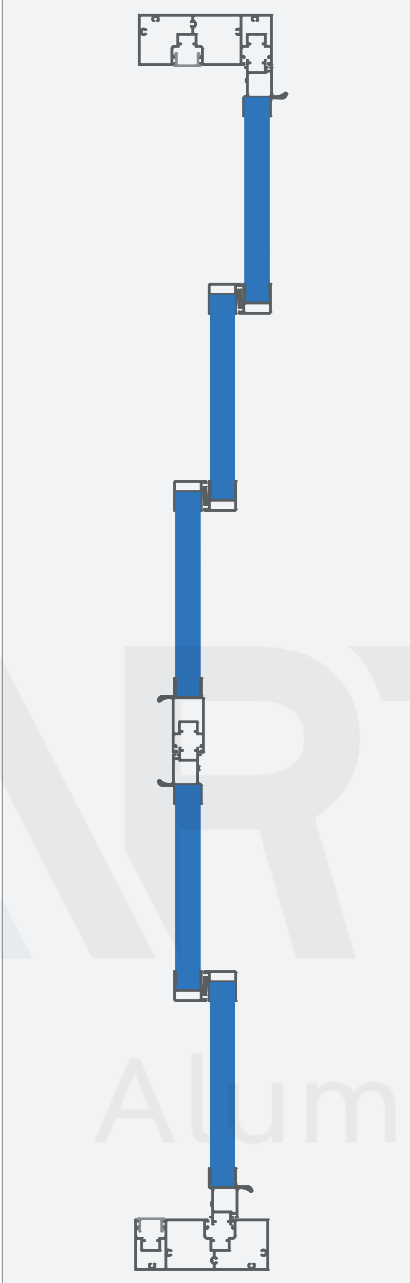

Beşli Sistem
Quintuple System

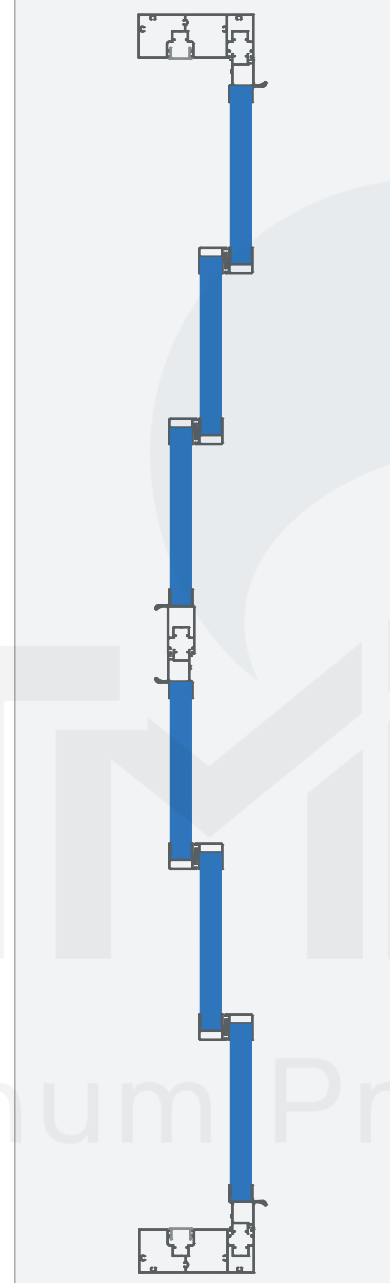

Altılı Sistem
Hexa System

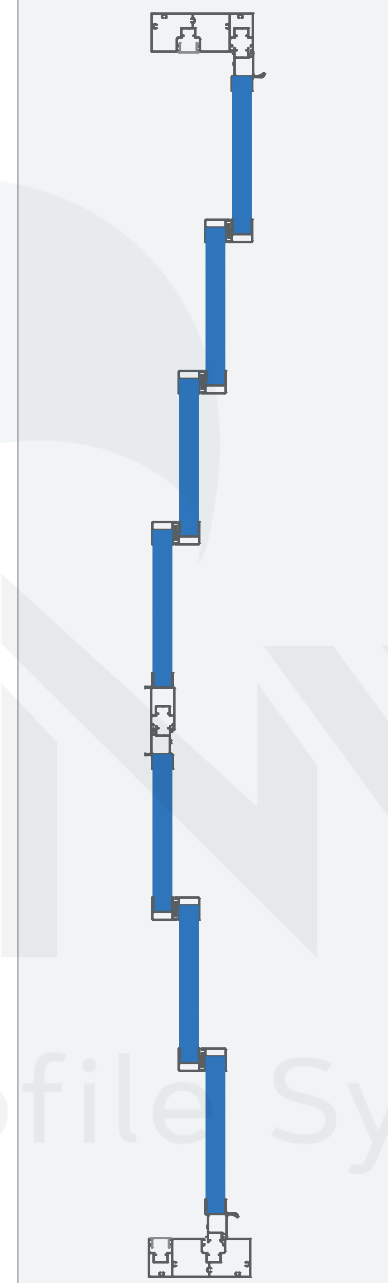

Yedili Sistem
Heptuple System

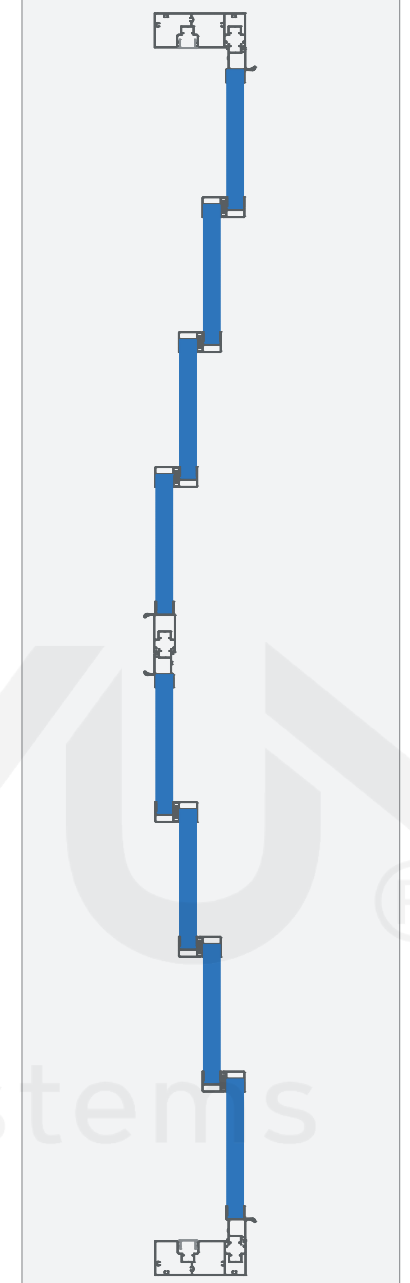

Sekizli Sistem
Octuple System

3 Meters (Max)

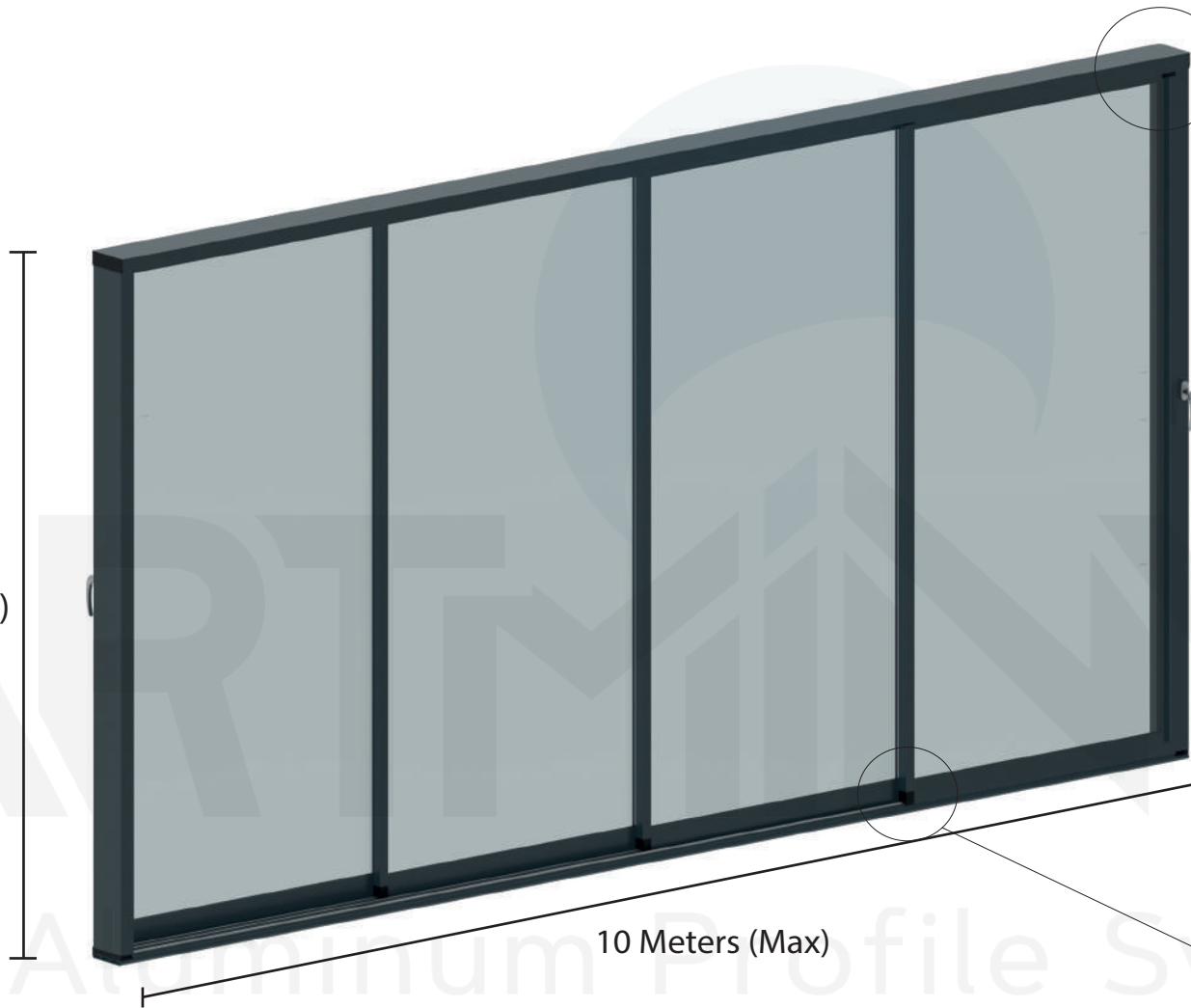

10 Meters (Max)

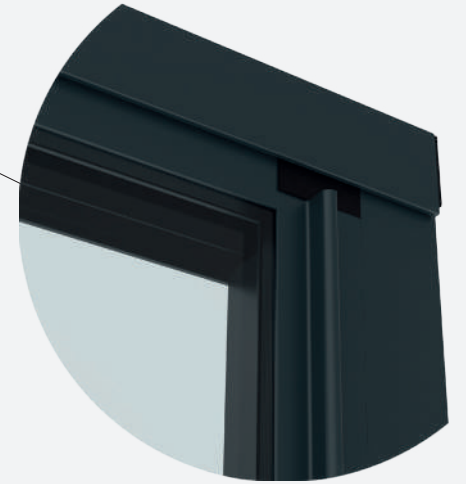

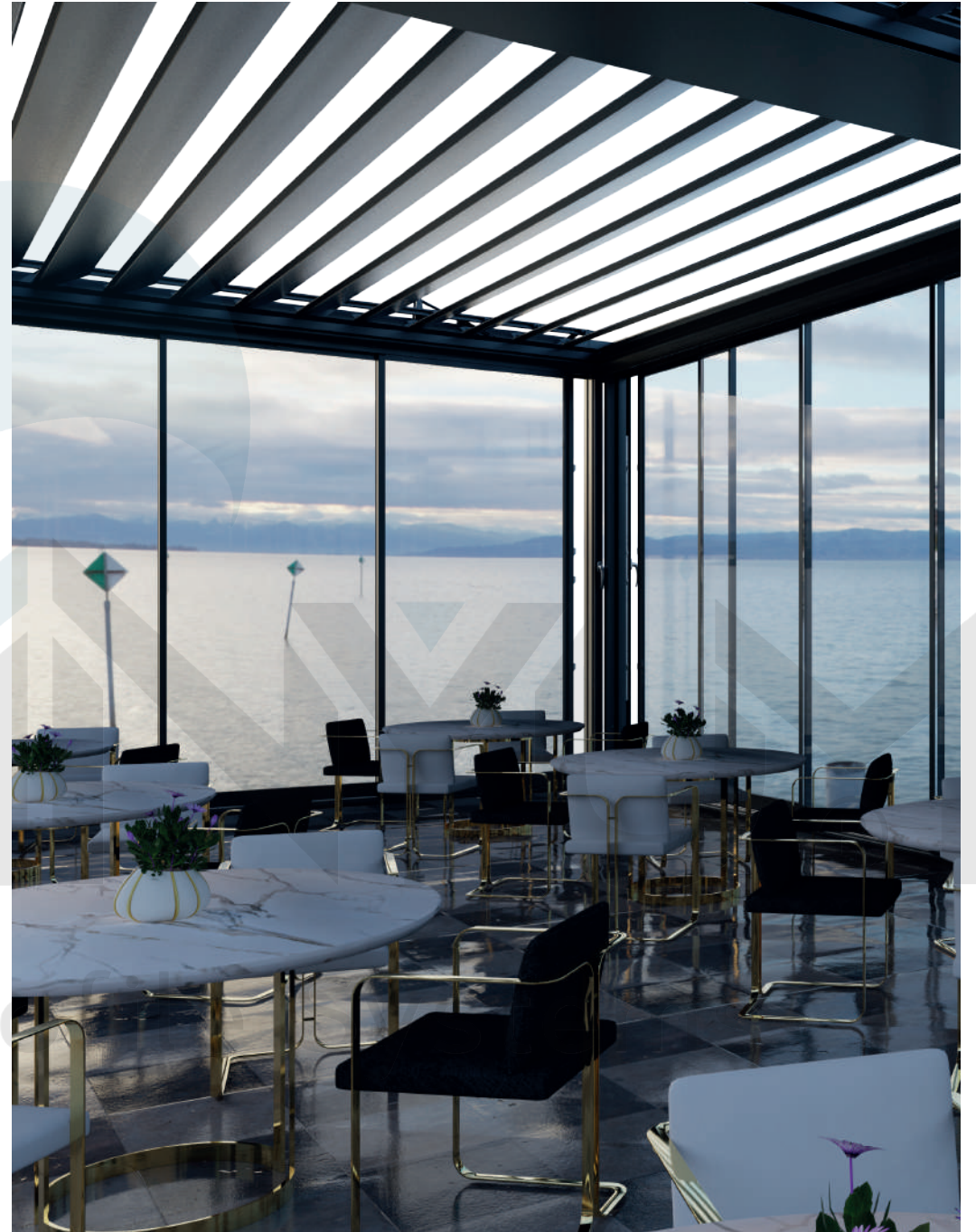

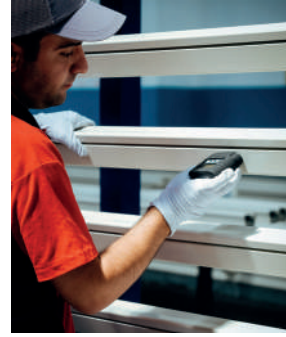
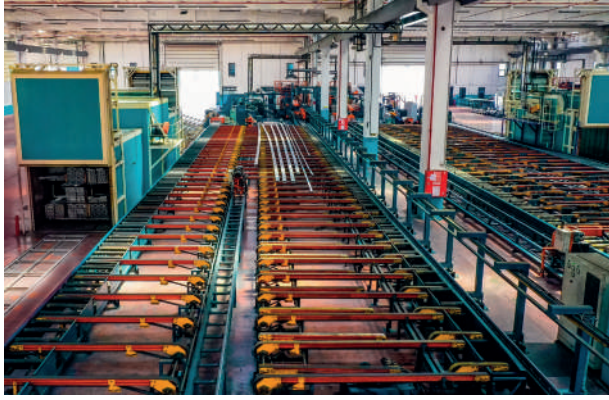

Biz Kimiz ?

Üstün kaliteli alüminyum profil üretimini her geçen gün artan standartlarla devam ettiren Kenan Metal A.Ş. ülkemizin önde gelen alüminyum fabrikalarından biridir. Mutlak müşteri ve çalışan memnuniyeti prensibiyle üretim yapan Kenan Metal A.Ş., tente pergola, inşaat ve özel profiller gibi farklı sektörlerin mevcut ve gelecekteki beklentilerini karşılayan, çevreyle dost üretim sistemlerini benimseyen, küresel etkileşimleri yakından takip ederek sürekli yenilenen, çağdaş bir vizyonla gelişiyor. Ürün-kalite çitasının sürekli yükselmesi, ürün yelpazesinin geliştirilmesi, yeni ürünlerin tasarımı, kullanım alanlarının artırılması için sürekli olarak çalışan Ar-Ge bölümüyle göz dolduran Kenan Metal A.Ş., kalitesi güvenilirliği, kullandığı teknoloji ve özel çözümler üretme gücüyle pazar payını sürekli genişletiyor.

Kenan Metal A.Ş., alüminyum bazlı ürünlerin kalitelerini artırarak ve kullanım alanlarını yaygınlaştırarak doğal ve estetik mekanların yaratılmasına da öncülük ediyor. Her yapı için kendine özgü üstün nitelikli ve ileri teknoloji gerektiren çağdaş çözümler sunan Kenan Metal A.Ş., esnek yaklaşımları üstün hizmet kalitesi ve fiyat-kalite dengesiyle küresel pazarda söz sahibi bir kurum olma yolunda emin adımlarla ilerliyor.

Who Are We?

Kenan Metal is one of the leading aluminum factories of our country which continues to produce high quality aluminum profiles with increasing standards each passing day. Kenan Metal which makes production with absolute customer and employee satisfaction principle, develops with a modern vision that meets current and future expectations of different sectors such as awning pergola, construction and special profiles, adopts environmentally friendly production systems, renews itself constantly by following global interactions closely.

Kenan Metal which makes a strong impression with its R&D department working constantly for raising product-quality level, improving product range, designing new products, increasing usage areas, expands its market share constantly with its quality, credibility technology used and power to produce special solutions

Kenan Metal is also leading creation of natural and aesthetic spaces by increasing quality of aluminum-based products and expanding usage areas. Kenan Metal which offers its unique, superior and modern solutions requiring advanced technology for every structure, is moving confidently on its way to become a promising company in global market with its flexible approaches, superior service quality and price-quality balance.



KENAN METAL®





kenanmetal.com | info@kenanmetal.com | +90 212 485 60 35

Genel Merkez : İosb Mh. Atatürk Blv. Mahmut Torun İş Merkezi No: 54 Kat: 1 34490 İkitelli Osb / Başakşehir / İstanbul
Fabrika : Velimeşe Mahallesi, Kandil Caddesi, 329 Sokak, Dış Kapı No:7 Ergene / Tekirdağ

