

KENAN METAL

ARTMINYUM

MODENA SÜRME CAM SİSTEMLERİ

MODENA SLIDING GLASS
SYSTEMS

MODENA SÜRME CAM SİSTEMLERİ

MODENA SLIDING GLASS SYSTEMS



Aluminyum Profile Sistemleri

ALÜMİNYUM ÇERÇEVELER, UZUN ÖMÜRLÜ VE DAYANIKLI BİR YAPI SUNAR. MODERN VE ŞİK TASARIMIYLA İÇ MEKANLARA ESTETİK BİR DOKUNUŞ KATAR.

PASLANMAYA KARŞI DAYANIKLI OLAN ALÜMİNYUM, TEMİZLİĞİ KOLAYDIR VE DÜZENLİ BAKIM GEREKTİRMEZ.

SÜRGÜLÜ CAMLAR, KULLANICILARIN İÇ MEKANLARA DAHA FAZLA DOĞAL IŞIK VE MANZARA GETİRMESİNİ SAĞLAR. AYRICA, FARKLI BOYUTLARDA VE TASARIMLARDA MEVCUTTUR, BÖYLECE FARKLI MEKAN İHTİYAÇLARINA UYUM SAĞLAR.

ALUMINIUM FRAMES PROVIDE A LONG-LASTING AND DURABLE STRUCTURE. WITH ITS MODERN AND STYLISH DESIGN, IT ADDS AN AESTHETIC TOUCH TO INDOOR SPACES.

ALUMINIUM, RESISTANT TO CORROSION, IS EASY TO CLEAN AND DOES NOT REQUIRE REGULAR MAINTENANCE.

SLIDING GLASS DOORS ALLOW USERS TO BRING MORE NATURAL LIGHT AND SCENERY INTO INDOOR SPACES. THEY ARE ALSO AVAILABLE IN DIFFERENT SIZES AND DESIGNS, THEREBY ADAPTING TO DIFFERENT SPACE REQUIREMENTS.



Aluminum Profile Systems

Outdoor Of Art
Dış Mekanda Sanat



RAL RENK STANDARDINA GÖRE SEÇTİĞİNİZ TÜM RENKLER UYGULANABİLİR.

COLOURING OF YOUR CHOICE, ACCORDING TO THE RAL COLOUR STANDARD.



YAĞMUR VE RÜZGAR GİBİ HAVA ŞARTLARINA SON DERECE DAYANIKLIDIR.

IT IS EXTREMELY RESISTANT TO WEATHER CONDITIONS SUCH AS RAIN AND WIND.



MATERYAL // 6063 T5 ALÜMİNYUM, PASLANMAZ ÇELİK VE DERLİN.

MATERIALS // 6063 T5 ALUMINUM, STAINLESS STEEL AND DERLİN.

ÖZELLİKLE MODERN MİMARİ TASARIMLARDA SIKLIKLA KULLANILIRLAR VE İÇ MEKANLARA ŞIKLIK VE FERAHLIK KATARLAR. BALKON KAPILARI, TERAS KAPILARI, VERANDA KAPILARI VE İÇ BÖLME DUVARLARI GİBİ FARKLI ALANLARDA KULLANILABİLİRLER.

ALÜMİNYUM SÜRME CAM SİSTEMLERİ, MODERN VE ŞİK TASARIMLARA SAHİP OLABİLİRLER. FARKLI RENK VE KAPLAMA SEÇENEKLERİ İLE MEKANA ESTETİK BİR GÖRÜNÜM KAZANDIRABİLİRLER. AYRICA, ŞEFFAF CAMLAR VE MINİMAL ÇERÇEVELERLE FERAH VE AÇIK BİR İÇ MEKAN YARATILMASINI SAĞLARLAR.

DIŞ MEKAN OTURMA ALANLARINI RÜZGAR, GÜNEŞ VE YAĞMURDAN KORUMAK AMACIYLA RESTORAN VE KAFE GİBİ TİCARİ MEKANLARDA TERCİH EDİLİR.

ESPECIALLY IN MODERN ARCHITECTURAL DESIGNS, THEY ARE FREQUENTLY USED AND ADD ELEGANCE AND SPACIOUSNESS TO INDOOR SPACES. THEY CAN BE USED IN DIFFERENT AREAS SUCH AS BALCONY DOORS, TERRACE DOORS, VERANDA DOORS, AND INTERIOR PARTITION WALLS.

ALUMINUM SLIDING GLASS SYSTEMS CAN HAVE MODERN AND STYLISH DESIGNS. THEY CAN PROVIDE AN AESTHETIC APPEARANCE TO THE SPACE WITH DIFFERENT COLOR AND COATING OPTIONS. ADDITIONALLY, THEY ALLOW FOR CREATING A SPACIOUS AND OPEN INDOOR ENVIRONMENT WITH TRANSPARENT GLASS AND MINIMAL FRAMES.

THEY ARE PREFERRED IN COMMERCIAL SPACES SUCH AS RESTAURANTS AND CAFES TO PROTECT OUTDOOR SEATING AREAS FROM WIND, SUN, AND RAIN.

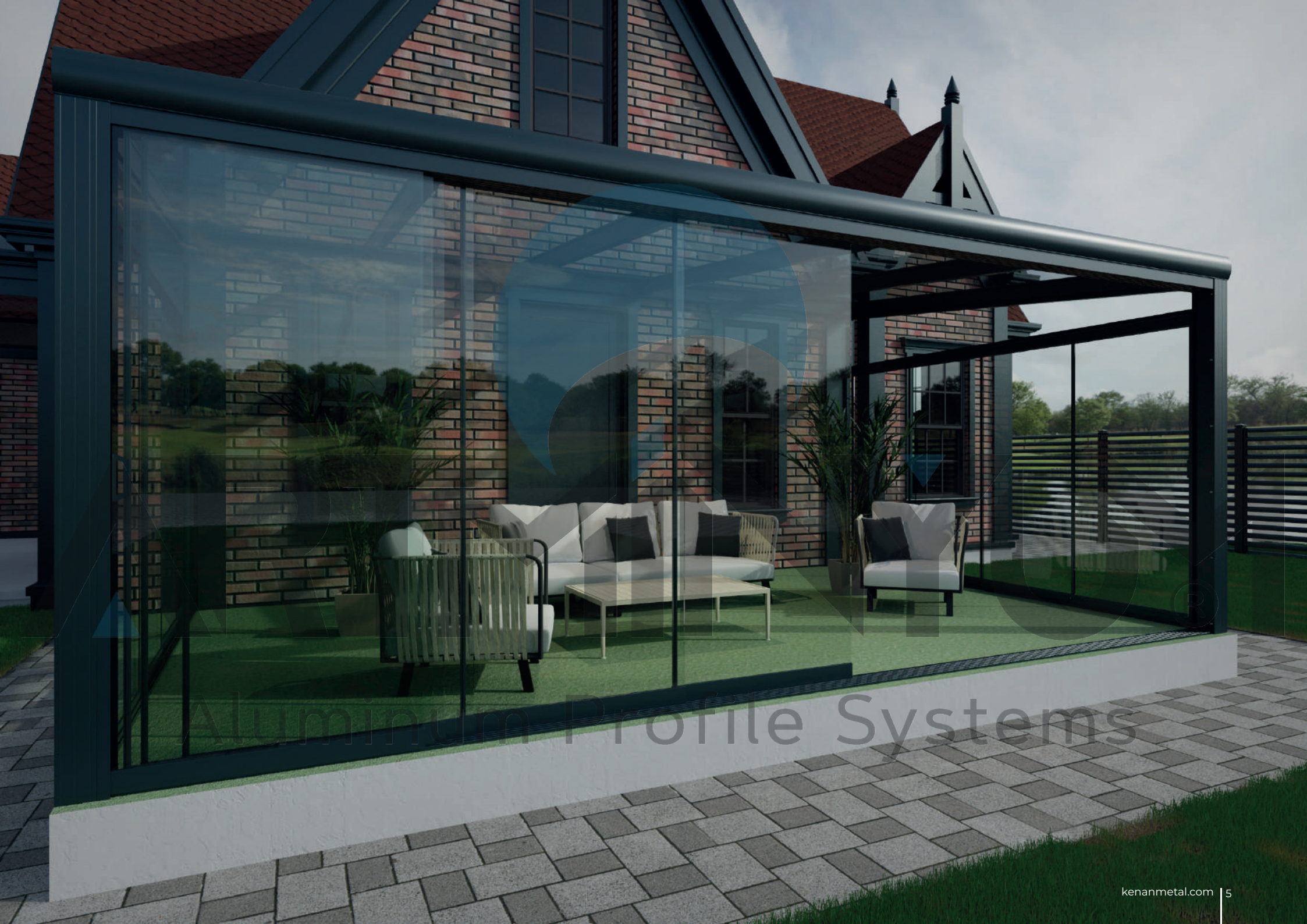

Aluminum Profile Systems

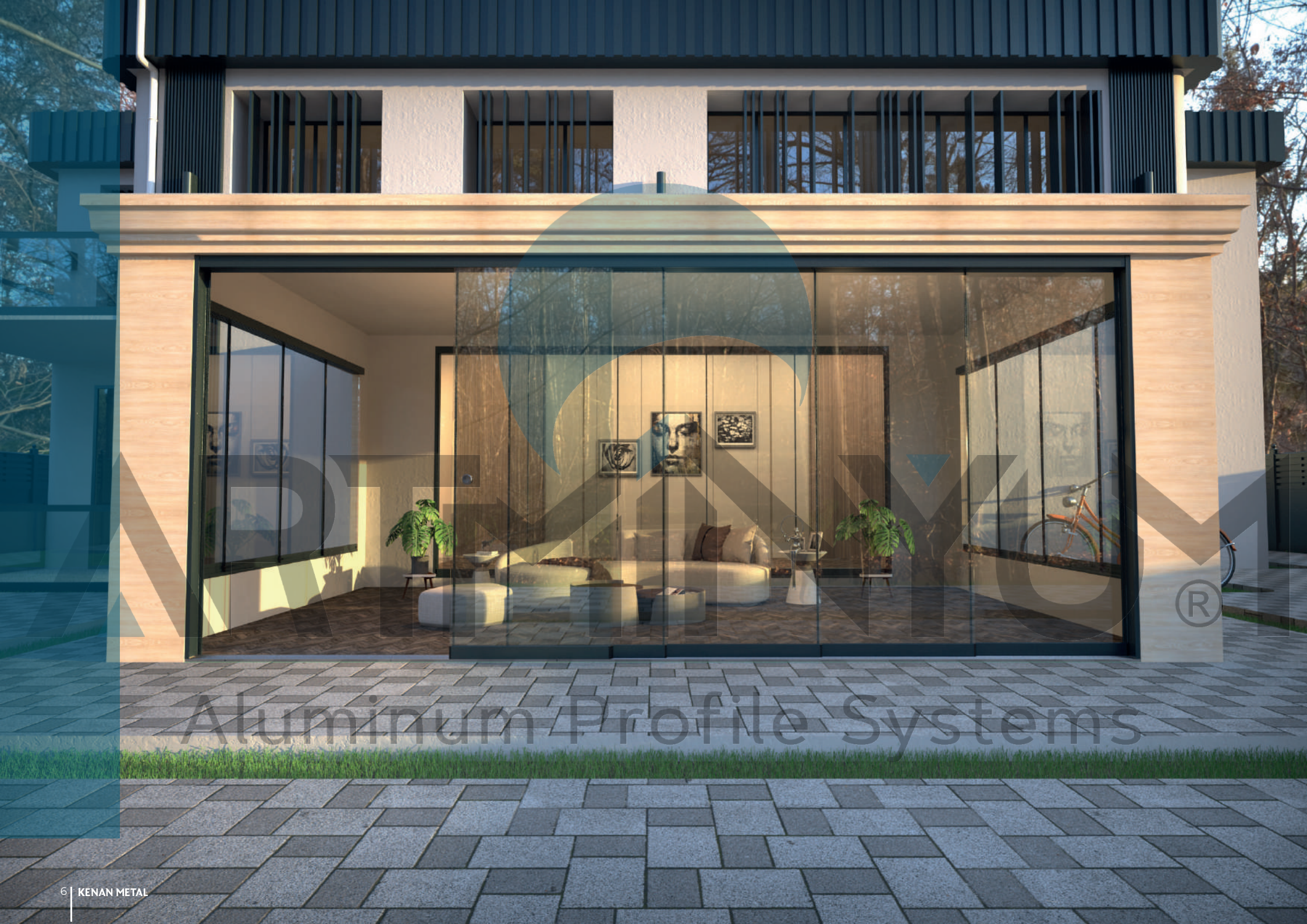

Aluminum Profile Systems



2'Lİ , 3'LÜ , 4'LÜ , 5'Lİ VE 6'Lİ OLMAK ÜZERE 5 FARKLI OPSİYONU BULUNMAKTADIR.
"THERE ARE 5 DIFFERENT OPTIONS AVAILABLE: 2-PIECE, 3-PIECE, 4-PIECE, 5-PIECE, AND 6-PIECE."



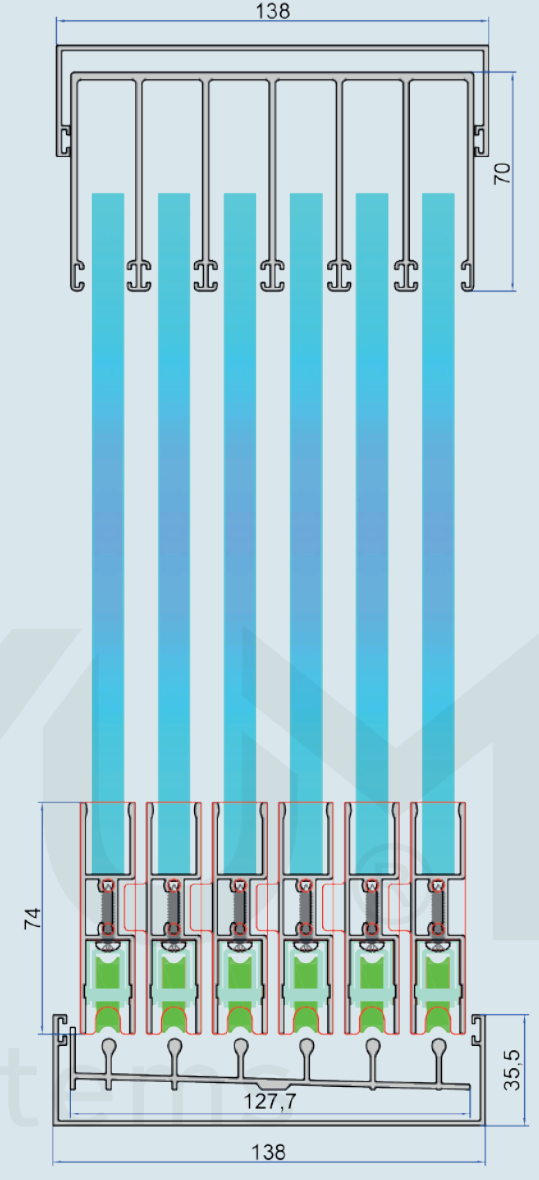
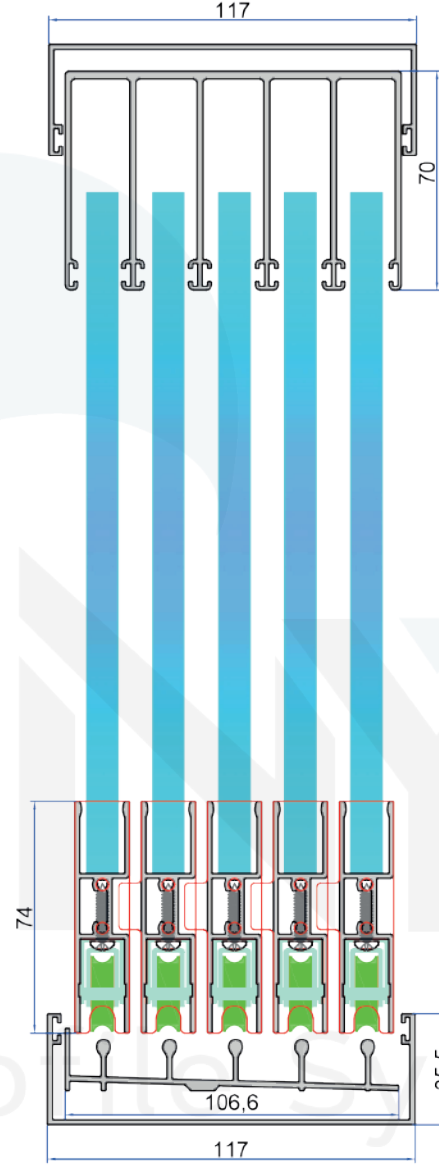
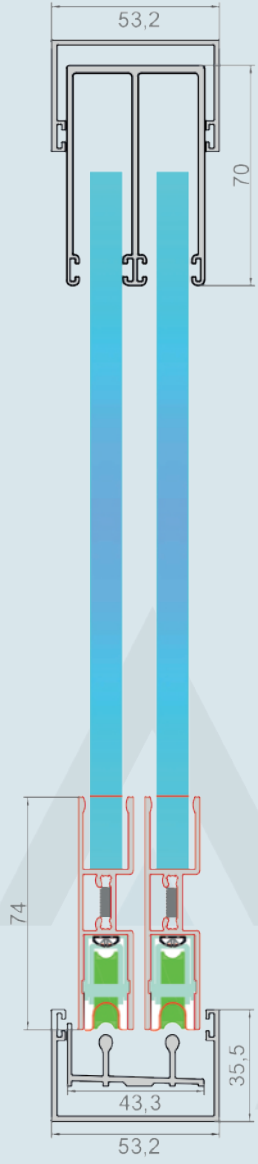

İKİLİ CAM SİSTEMİ
DOUBLE GLAZING SYSTEM

ÜÇLÜ CAM SİSTEMİ
TRIPLE GLAZING SYSTEM

DÖRTLÜ CAM SİSTEMİ
FOUR GLAZING SYSTEM

BEŞLİ CAM SİSTEMİ
FIVE GLAZING SYSTEM

ALTILİ CAM SİSTEMİ
SIX GLAZING SYSTEM

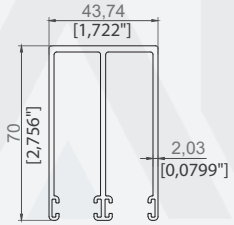

İKİLİ ÜST RAY PROFİLİ
TWO RAIL TOP PROFILE

ÜRÜN KODU / PRODUCT CODE	3774
AĞIRLIK / WEIGHT	1,466 KG/M 3,232 LB/M

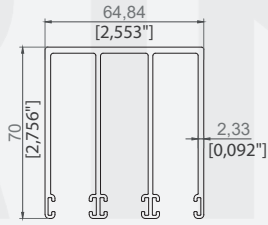

ÜÇLÜ ÜST RAY PROFİLİ
THREE RAIL TOP PROFILE

ÜRÜN KODU / PRODUCT CODE	2957
AĞIRLIK / WEIGHT	2,081 KG/M 4,588 LB/M

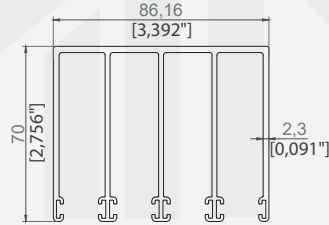
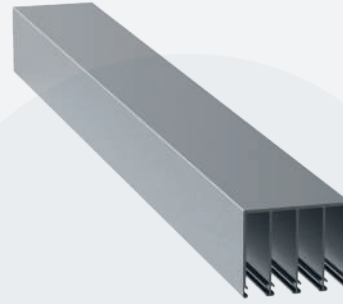

DÖRTLÜ ÜST RAY PROFİLİ
FOUR RAIL TOP PROFILE

ÜRÜN KODU / PRODUCT CODE	2958
AĞIRLIK / WEIGHT	2,629 KG/M 5,796 LB/M

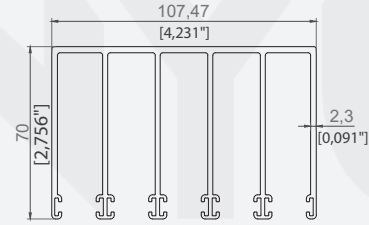
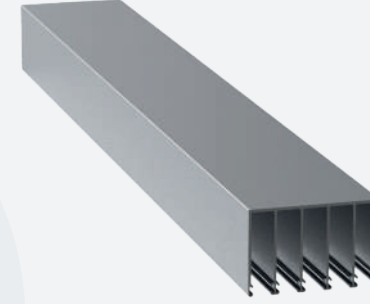

BEŞLİ ÜST RAY PROFİLİ
FIVE RAIL TOP PROFILE

ÜRÜN KODU / PRODUCT CODE	2959
AĞIRLIK / WEIGHT	3,228 KG/M 7,117 LB/M

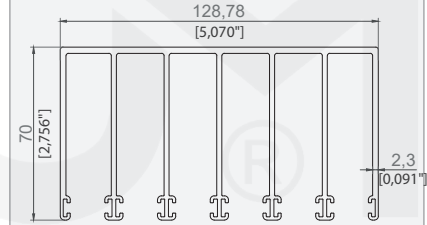
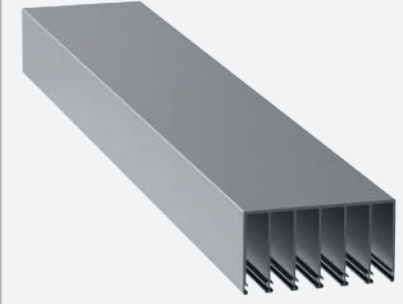

ALTILI ÜST RAY PROFİLİ
SIX RAIL TOP PROFILE

ÜRÜN KODU / PRODUCT CODE	2960
AĞIRLIK / WEIGHT	3,786 KG/M 8,347 LB/M

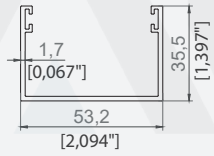

İKİLİ YAN DİKME PROFİLİ
TWO SIDE PILLAR PROFILE

ÜRÜN KODU / PRODUCT CODE	3776
AĞIRLIK / WEIGHT	0,613 KG/M 1,351 LB/M

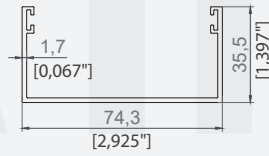

ÜÇLÜ YAN DİKME PROFİLİ
THREE SIDE PILLAR PROFILE

ÜRÜN KODU / PRODUCT CODE	2961
AĞIRLIK / WEIGHT	0,710 KG/M 1,565 LB/M

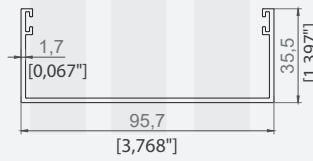
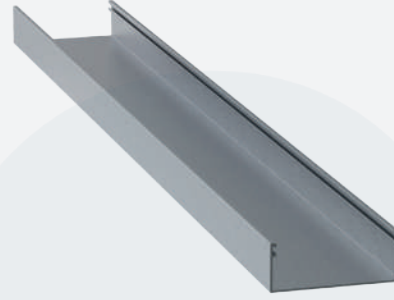

DÖRTLÜ YAN DİKME PROFİLİ
FOUR SIDE PILLAR PROFILE

ÜRÜN KODU / PRODUCT CODE	2962
AĞIRLIK / WEIGHT	0,810 KG/M 1,786 LB/M

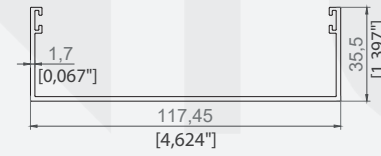

BEŞLİ YAN DİKME PROFİLİ
FIVE SIDE PILLAR PROFILE

ÜRÜN KODU / PRODUCT CODE	2963
AĞIRLIK / WEIGHT	0,910 KG/M 2,006 LB/M

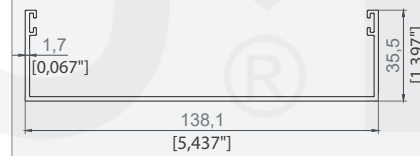

ALTILI YAN DİKME PROFİLİ
SIX SIDE PILLAR PROFILE

ÜRÜN KODU / PRODUCT CODE	2964
AĞIRLIK / WEIGHT	1,006 KG/M 2,218 LB/M

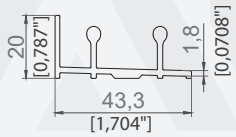

İKİLİ ALT RAY PROFİLİ
TWO BOTTOM RAIL PROFILE

ÜRÜN KODU / PRODUCT CODE	3775
AĞIRLIK / WEIGHT	0,504 KG/M 1,111 LB/M

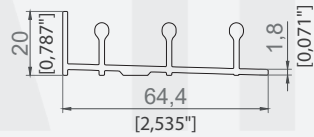
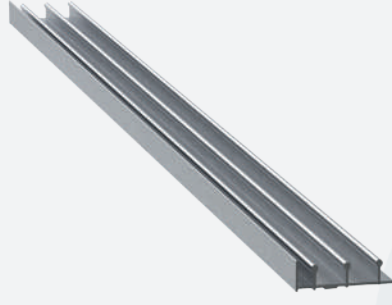

ÜÇLÜ ALT RAY PROFİLİ
THREE BOTTOM RAIL PROFILE

ÜRÜN KODU / PRODUCT CODE	2869
AĞIRLIK / WEIGHT	0,696 KG/M 1,534 LB/M

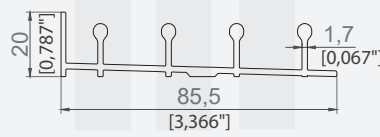
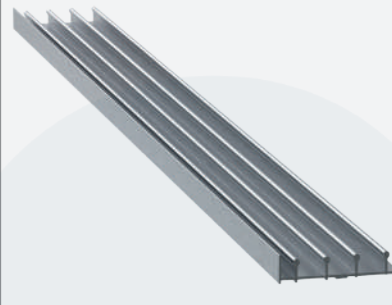

DÖRTLÜ ALT RAY PROFİLİ
FOUR BOTTOM RAIL PROFILE

ÜRÜN KODU / PRODUCT CODE	2870
AĞIRLIK / WEIGHT	0,894 KG/M 1,971 LB/M

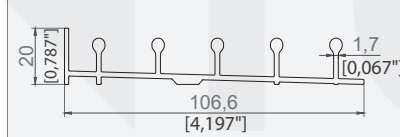
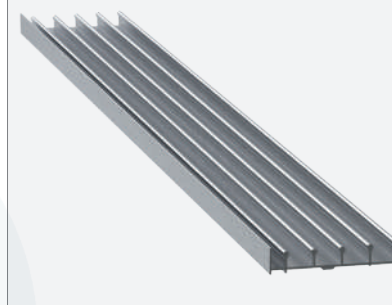

BEŞLİ ALT RAY PROFİLİ
FIVE BOTTOM RAIL PROFILE

ÜRÜN KODU / PRODUCT CODE	2871
AĞIRLIK / WEIGHT	1,089 KG/M 2,401 LB/M

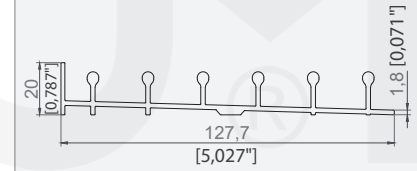
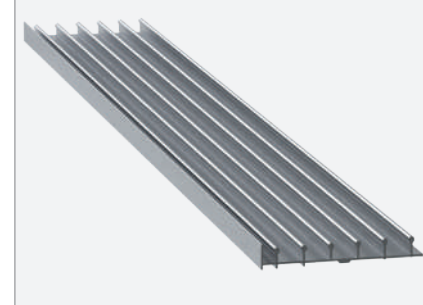

ALTILİ ALT RAY PROFİLİ
SIX BOTTOM RAIL PROFILE

ÜRÜN KODU / PRODUCT CODE	2872
AĞIRLIK / WEIGHT	1,287 KG/M 2,837 LB/M

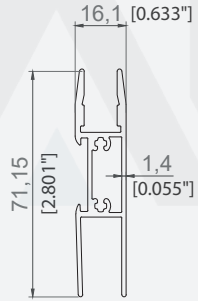

SÜRME PANEL ALT PROFİLİ - 1
TWO BOTTOM RAIL PROFILE - 1

ÜRÜN KODU / PRODUCT CODE	3497
AĞIRLIK / WEIGHT	0,829 KG/M 1,828 LB/M

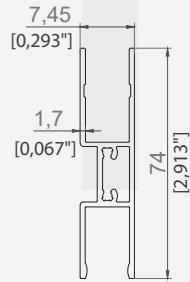

SÜRME PANEL ALT PROFİLİ - 2
TWO BOTTOM RAIL PROFILE - 2

ÜRÜN KODU / PRODUCT CODE	2868
AĞIRLIK / WEIGHT	0,825 KG/M 1,819 LB/M

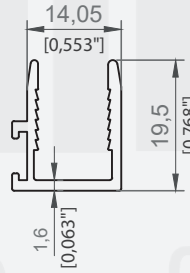
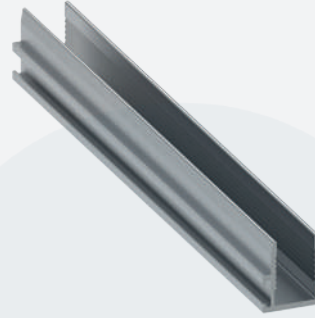

10 MM CAM TUTUCU
10 MM GLASS HOLDER

ÜRÜN KODU / PRODUCT CODE	2670
AĞIRLIK / WEIGHT	0,230 KG/M 0,507 LB/M



MODENA SÜRME CAM SİSTEMİ
AKSESUARLARI

MODENA SLIDING GLASS
SYSTEM
ACCESSORIES



6.7 X 550 KIL FİTİL
6.7 X 550 COTTON WICK

KOD / CODE
ADET / PIECE

SRM-14
375mt X 4 RULO
375mt X 4 ROLL



6.7 X 1200 KIL FİTİL
6.7 X 1200 COTTON WICK

KOD / CODE
ADET / PIECE

SRM-24
375mt X 4 RULO
375mt X 4 ROLL



SÜRME CAM FİTİLİ EPDM ECO
SLIDING GLASS SEAL EPDM ECO

KOD / CODE
ADET / PIECE

SRM-18
100 MT



SÜRME TEKER PROFİLİ ÇEKİCİ KAPAĞI ECO
SLIDING WHEEL PROFILE COVER ECO

KOD / CODE
ADET / PIECE

SRM-19
100



SÜRME TEKER PROFİLİ SONLAMA KAPAĞI ECO
SLIDING WHEEL PROFILE END CAP ECO

KOD / CODE
ADET / PIECE

SRM-20
100



SÜRME TEKER ECO
SLIDING WHEEL ECO

KOD / CODE
ADET / PIECE

SRM-21
200



SÜRME CAM TAKOZU ECO
SLIDING GLASS WEDGE ECO

KOD / CODE
ADET / PIECE

SRM-22
100



MODENA SÜRME CAM KULBU - ANTRASİT
MODENA SLIDING HANDLE - ANTHRACITE

KOD / CODE
ADET / PIECE

SRM-25
2



MODENA SÜRME CAM KULBU - SİYAH
MODENA SLIDING HANDLE - BLACK

KOD / CODE
ADET / PIECE

SRM-25-1
2



MODENA SÜRME CAM KULBU - PRESS
MODENA SLIDING HANDLE - PRESS

KOD / CODE
ADET / PIECE

SRM-25-2
2

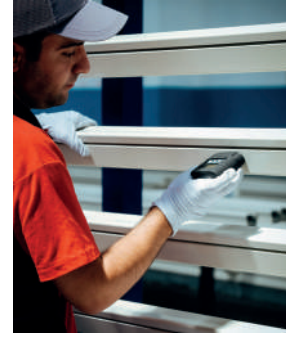
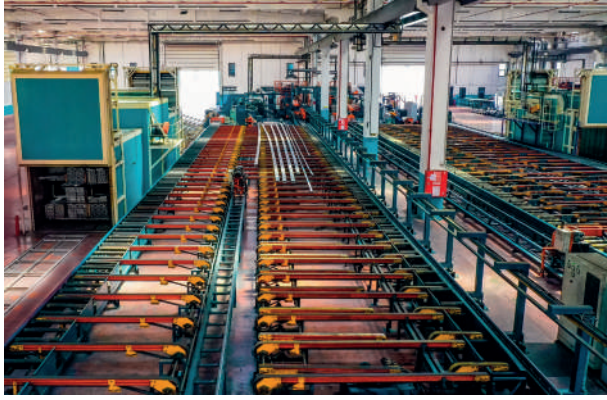

Biz kimiz ?

ÜSTÜN KALİTELİ ALÜMİNYUM PROFİL ÜRETİMİNİ HER GEÇEN GÜN ARTAN STANDARTLARLA DEVAM ETTİREN KENAN METAL A.Ş. ÜLKEMİZİN ÖNDE GELEN ALÜMİNYUM FABRİKALARINDAN BİRİDİR. MUTLAK MÜŞTERİ VE ÇALIŞAN MEMNUNİYETİ PRENSİBİYLE ÜRETİM YAPAN KENAN METAL A.Ş., TENTE PERGOLA, İNŞAAT VE ÖZEL PROFİLLER GİBİ FARKLI SEKTÖRLERİN MEVCUT VE GELECEKTEKİ BEKLENTİLERİNİ KARŞILAYAN, ÇEVREYLE DOST ÜRETİM SİSTEMLERİNİ BENİMSEYEN, KÜRESEL ETKİLEŞİMLERİ YAKINDAN TAKİP EDEREK SÜREKLİ YENİLENEN, ÇAĞDAŞ BİR VİZYONLA GELİŞİYOR. ÜRÜN-KALİTE ÇİTASININ SÜREKLİ YÜKSEKİLMESİ, ÜRÜN YELPAZESİNİN GELİŞTİRİLMESİ, YENİ ÜRÜNLERİN TASARIMI, KULLANIM ALANLARININ ARTTIRILMASI İÇİN SÜREKLİ OLARAK ÇALIŞAN AR-GE BÖLÜMÜYLE GÖZ DOLDURAN KENAN METAL A.Ş., KALİTESİ GÜVENİLİRLİĞİ, KULLANDIĞI TEKNOLOJİ VE ÖZEL ÇÖZÜMLER ÜRETME GÜCÜYLE PAZAR PAYINI SÜREKLİ GENİŞLETİYOR.

KENAN METAL A.Ş., ALÜMİNYUM BAZLI ÜRÜNLERİN KALİTELERİNİ ARTTIRARAK VE KULLANIM ALANLARINI YAYGINLAŞTIRARAK DOĞAL VE ESTETİK MEKANLARIN YARATILMASINA DA ÖNCÜLÜK EDİYOR. HER YAPI İÇİN KENDİNE ÖZGÜ ÜSTÜN NİTELİKLİ VE İLERİ TEKNOLOJİ GEREKTİREN ÇAĞDAŞ ÇÖZÜMLER SUNAN KENAN METAL A.Ş., ESNEK YAKLAŞIMLARI ÜSTÜN HİZMET KALİTESİ VE FİYAT-KALİTE DENGESİYLE KÜRESEL PAZARDA SÖZ SAHİBİ BİR KURUM OLMA YOLUNDA EMİN ADIMLARLA İLERLİYOR.

WHO ARE WE?

KENAN METAL IS ONE OF THE LEADING ALUMINUM FACTORIES OF OUR COUNTRY WHICH CONTINUES TO PRODUCE HIGH QUALITY ALUMINUM PROFILES WITH INCREASING STANDARDS EACH PASSING DAY. KENAN METAL WHICH MAKES PRODUCTION WITH ABSOLUTE CUSTOMER AND EMPLOYEE SATISFACTION PRINCIPLE, DEVELOPS WITH A MEDERN VISION THAT MEETS CURRENT AND FUTURE EXPECTATIONS OF DIFFERENT SECTORS SUCH AS AWNING PERGOLA, CONSTRUCTION AND SPECIAL PROFILES, ADOPTS ENVIRONMENTALLY FRIENDLY PRODUCTION SYSTEMS, RENEWS ITSELF CONSTANTLY BY FOLLOWING GLOBAL INTERACTIONS CLOSELY.

KENAN METAL WHICH MAKES A STRONG IMPRESSION WITH ITS R&D DEPARTMENT WORKING CON STANTLY FOR RAISING PRODUCT-QUALITY LEVEL, IMPROVING PRODUCT RANGE, DESIGNING NEW PRODUCTS, INCREASING USAGE AREAS, EXPANDS ITS MARKET SHARE CONSTANTLY WITH ITS QUALITY, CREDIBILITY TECHNOLOGY USED AND POWER TO PRODUCE SPECIAL SOLUTIONS KENAN METAL IS ALSO LEADING CREATION OF NATURAL AND AESTHETIC SPACES BY INCREASING QUALITY OF ALUMINUM-BASED PRODUCTS AND EXPANDING USAGE AREAS. KENAN METAL WHICH OFFERS ITS UNIQUE, SUPERIOR AND MODERN SOLUTIONS REQUIRING ADVANCED TECHNOLOGY FOR EVERY STRUCTURE, IS MOVING CONFIDENTLY ON ITS WAY TO BECAME A PROMISING COMPANY IN GLOBAL MARKET WITH ITS FLEXIBLE APPROACHES, SUPERIOR SERVICE QUALITY AND PRICE-QUALITY BALANCE.



KENAN METAL®





KENANMETAL.COM | INFO@KENANMETAL.COM | +90 212 485 60 35

GENEL MERKEZ : İOSB MH. ATATÜRK BLV. MAHMUT TORUN İŞ MERKEZİ NO: 54 KAT:1 34490 İKİTELLİ OSB / BAŞAKŞEHİR / İSTANBUL
FABRİKA : VELİMEŞE MAHALLESİ, KANDİL CADDESİ, 329 SOKAK, DIŞ KAPI NO:7 ERGENE / TEKİRDAĞ

