

KENAN METAL

ARTMINYUM

LOTUS TEMİZLENEBİLİR GİYOTİN SİSTEMİ

Lotus Cleansable
Guillotine System

LOTUS TEMİZLENEBİLİR GİYOTİN SİSTEMİ

Lotus Cleansable Guillotine System



Giyotin cam sistemi, genellikle büyük cam yüzeylerin açılabilir pencere veya kapı olarak kullanılabilmesini sağlayan bir tür cam sistemi veya cam düzenlemesini ifade eder. Bu sistem, özellikle ticari binalarda, otellerde veya büyük yapılarda tercih edilen bir cam açma mekanizmasıdır.

Giyotin cam sistemi, mekanın doğal havalandırılması veya büyük cam yüzeylerin geçiş açıklıkları olarak kullanılabilmesi için idealdir. Özellikle güzel hava koşullarında iç ve dış mekan arasındaki geçişi kolaylaştırır.

Alüminyum giyotin sistemleri, modern bina tasarımında popüler bir tercih haline gelmiştir. Estetik açıdan çekici ve dayanıklı olmaları, birçok yapı projesinde tercih edilmelerinin nedenlerindedir. Ayrıca, enerji tasarrufu ve iç mekan konforunu artırma potansiyeli sunarlar.

The guillotine glass system generally refers to a type of glass system or arrangement that allows large glass surfaces to be used as operable windows or doors. This system is a preferred glass opening mechanism, particularly in commercial buildings, hotels, or large structures.

The guillotine glass system is ideal for natural ventilation of the space or for use as large glass openings. It facilitates the transition between indoor and outdoor environments, especially in good weather conditions.

Aluminum guillotine systems have become a popular choice in modern building design. Their aesthetic appeal and durability are among the reasons they are preferred in many construction projects. Additionally, they offer the potential to increase energy efficiency and indoor comfort.



Interior of Art

İç Yaşamda Sanat



RAL renk standardına göre seçtiğiniz tüm renkler uygulanabilir.

Colouring of your choice, according to the RAL colour standard.

Yağmur ve rüzgar gibi hava şartlarına son derece dayanıklıdır.

It is extremely resistant to weather conditions such as rain and wind.

Materyal // 6063 T5 alüminyum, paslanmaz çelik ve derlin.

Materials // 6063 T5 aluminum, stainless steel and derlin.

- Temizlenebilir giyotin cam sistemleri, cam panelleri yatay bir eksenle döndürerek temizlik işlemini kolaylaştırır. Bu sistem sayesinde cam yüzeylere erişim daha rahat ve güvenli hale gelir. Temizlik yapmak için cam panelleri indirip çıkarmak veya dışarıya çıkarmak gerekmez.
-
- Sistem komple kapalıyken camların iç yüzeyleri rahatlıkla silinebilmektedir.

"Cleanable guillotine glass systems facilitate the cleaning process by rotating the glass panels on a horizontal axis. This system makes accessing glass surfaces easier and safer. There is no need to lower or remove the glass panels or go outside to clean.

The inner surfaces of the glass can be easily cleaned when the system is fully closed."



Artminiyum



Sistem kapalı konumdayken , en alttaki cam kol yardımıyla içe açılarak dış yüzeyinin temizliği yapılabilir.

Ortada bulunan cam, en alttaki cam açık konuma geldikten sonra , açılarak dış yüzeyinin temizliği yapılabilir.

Sistemin tekrar normal açılıp kapanma konumuna alınabilmesi için kilit mekanizması kapalı konuma getirilmelidir.

Sistem komple açık konumdayken ise en üstteki camın dış yüzeyinin temizliği yapılabilir.

While the system is in the closed position, the bottommost glass can be opened inwards using the lever to clean its outer surface.

The glass in the middle can be opened for cleaning its outer surface after the bottommost glass is opened in the open position.

To return the system to its normal open and closed position, the locking mechanism must be closed.

When the system is fully open, the outer surface of the topmost glass can be cleaned.







ARTMINYUM®

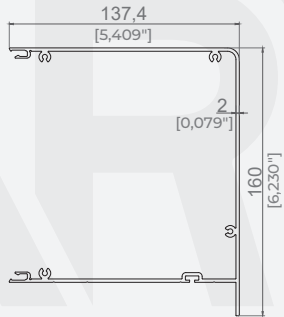

MOTOR KUTUSU PROFİLİ
MOTOR BOX PROFILE

Ürün Kodu / Product Code	37272
Ağırlık / Weight	2,700 kg/m 5,952 lb/m

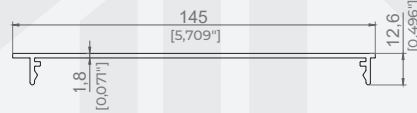
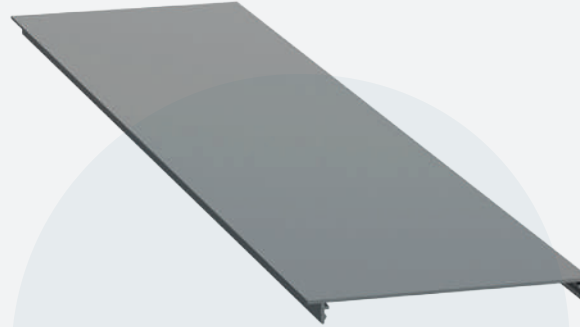

MOTOR KUTUSU KAPAK PROFİLİ
MOTOR BOX COVER PROFILE

Ürün Kodu / Product Code	37271
Ağırlık / Weight	0,847 kg/m 1,867 lb/m

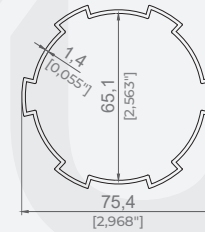

MOTOR TÜP PROFİLİ
MOTOR TUBE PROFILE

Ürün Kodu / Product Code	5312
Ağırlık / Weight	1,000 kg/m 2,205 lb/m

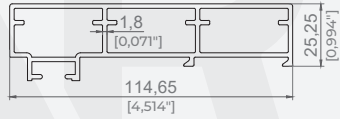

YAN RAY PROFİLİ
SIDE RAIL PROFILE

Ürün Kodu / Product Code	3570
Ağırlık / Weight	1,772 kg/m 3,906 lb/m

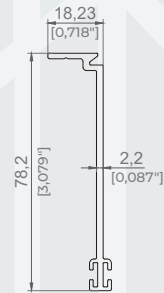
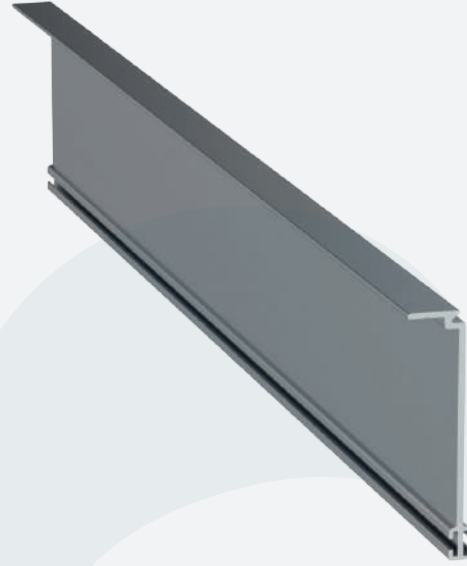

YAN RAY ORTA PROFİL
SIDE RAIL MIDDLE PROFILE

Ürün Kodu / Product Code	3073
Ağırlık / Weight	0,610 kg/m 1,345 lb/m

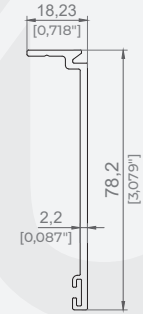

YAN RAY KAPAK PROFİLİ
SIDE RAIL COVER PROFILE

Ürün Kodu / Product Code	3071
Ağırlık / Weight	0,577 kg/m 1,272 lb/m

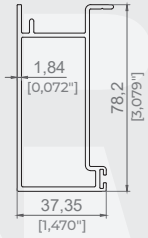

YAN RAY DİKME PROFİLİ
SIDE RAIL PILLAR PROFILE

Ürün Kodu / Product Code	3072
Ağırlık / Weight	1,170 kg/m 2,579 lb/m

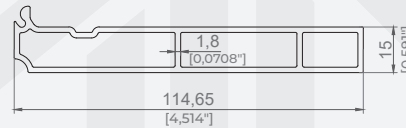
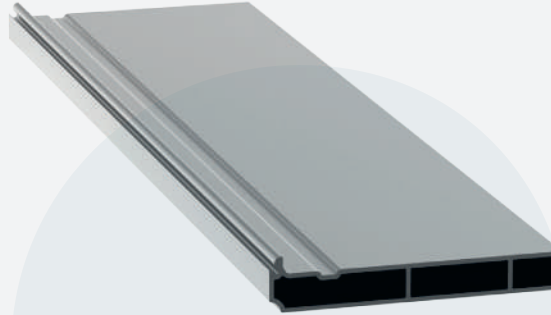

BAZA PROFİLİ
SILL PROFILE

Ürün Kodu / Product Code	3066
Ağırlık / Weight	1,400 kg/m 3,086 lb/m

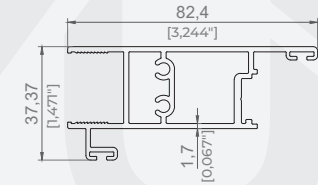

SABİT CAM YAN KİLİT PROFİLİ
FIXED GLASS SIDE LOCK PROFILE

Ürün Kodu / Product Code	3569
Ağırlık / Weight	1,257 kg/m 2,771 lb/m

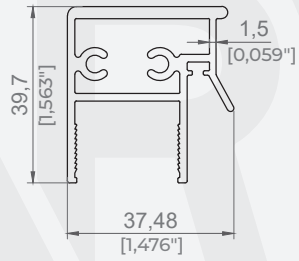
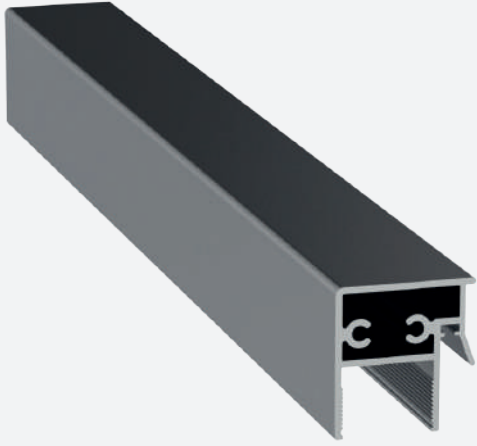

22MM CAM PANEL ÇEKİCİ PROFİLİ
22MM GLASS PANEL PULLER PROFILE

Ürün Kodu / Product Code	3068
Ağırlık / Weight	0,962 kg/m 2,121 lb/m

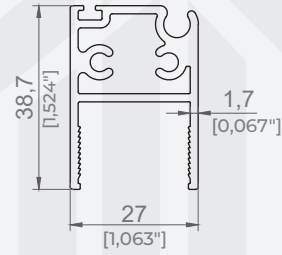

22MM TRABZAN PROFİLİ
22MM HANDRAİL PROFİLİ

Ürün Kodu / Product Code	3067
Ağırlık / Weight	0,800 kg/m 1,763 lb/m

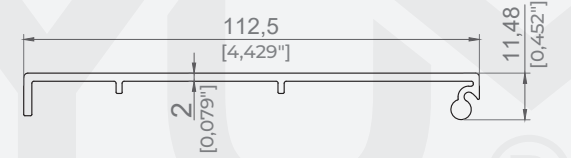
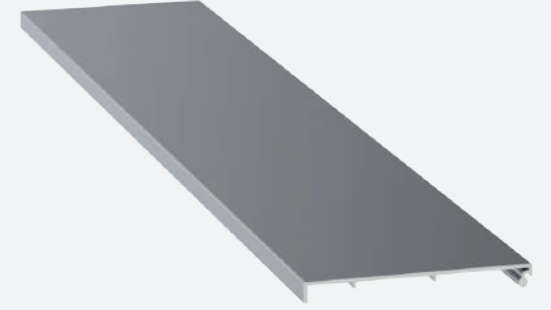

TRABZAN KAPAK PROFİLİ
HANDRAİL COVER PROFILE

Ürün Kodu / Product Code	3070
Ağırlık / Weight	0,770 kg/m 1,697 lb/m

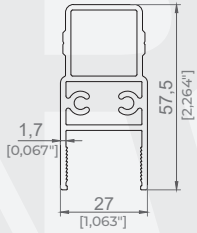





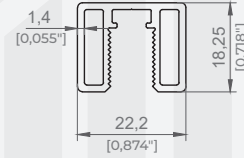
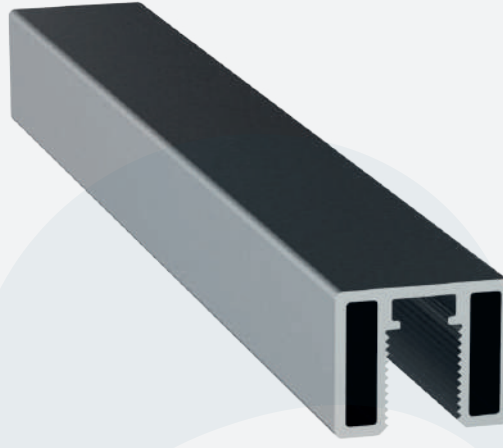











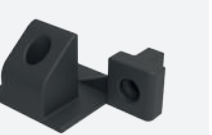
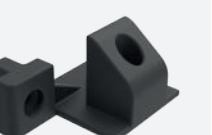





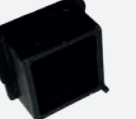

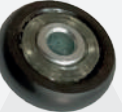
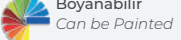



22MM CAM PANEL YAN PROFİL
22MM GLASS PANEL SIDE PROFILE

Ürün Kodu / Product Code	3064
Ağırlık / Weight	1,030 kg/m 2,271 lb/m



8MM CAM ADAPTÖR
8MM GLASS ADAPTER

Ürün Kodu / Product Code	3065
Ağırlık / Weight	0,370 kg/m 0,8157 lb/m

 <p>Lotus Zincirli Aksesuar Seti Yeni Kod: LTS-1Y</p> <p>Lotus Chain Accessories New Set Code: LTS-1Y</p>	 <p>Cam Köşe Takoza Glass Corner Wedge</p> <table border="1"> <tr> <td>Kod / Code</td> <td>LTS-8</td> </tr> <tr> <td>Adet / Piece</td> <td>2</td> </tr> </table>	Kod / Code	LTS-8	Adet / Piece	2	 <p>Tırnaklı Köşe Takoza Nailed Corner Wedge</p> <table border="1"> <tr> <td>Kod / Code</td> <td>LTS-8</td> </tr> <tr> <td>Adet / Piece</td> <td>6</td> </tr> </table>	Kod / Code	LTS-8	Adet / Piece	6	 <p>Sabit Köşe Takoza Üst Fixed Corner Wedge Top</p> <table border="1"> <tr> <td>Kod / Code</td> <td>LTS-8</td> </tr> <tr> <td>Adet / Piece</td> <td>2</td> </tr> </table>	Kod / Code	LTS-8	Adet / Piece	2	 <p>Dikme Ray Tırnak Plastiği Sewing Rail Nail Plastic</p> <table border="1"> <tr> <td>Kod / Code</td> <td>LTS-8</td> </tr> <tr> <td>Adet / Piece</td> <td>2</td> </tr> </table>	Kod / Code	LTS-8	Adet / Piece	2	 <p>Mafsal Plastiği Joint Plastic</p> <table border="1"> <tr> <td>Kod / Code</td> <td>LTS-8</td> </tr> <tr> <td>Adet / Piece</td> <td>2</td> </tr> </table>	Kod / Code	LTS-8	Adet / Piece	2	 <p>Sağ Panel Sabitleyici Plastik Panel Fixing Plastic Right</p> <table border="1"> <tr> <td>Kod / Code</td> <td>LTS-1Y</td> </tr> <tr> <td>Adet / Piece</td> <td>1</td> </tr> </table>	Kod / Code	LTS-1Y	Adet / Piece	1	 <p>Sol Panel Sabitleyici Plastik Panel Fixing Plastic Left</p> <table border="1"> <tr> <td>Kod / Code</td> <td>LTS-1Y</td> </tr> <tr> <td>Adet / Piece</td> <td>1</td> </tr> </table>	Kod / Code	LTS-1Y	Adet / Piece	1				
Kod / Code	LTS-8																																						
Adet / Piece	2																																						
Kod / Code	LTS-8																																						
Adet / Piece	6																																						
Kod / Code	LTS-8																																						
Adet / Piece	2																																						
Kod / Code	LTS-8																																						
Adet / Piece	2																																						
Kod / Code	LTS-8																																						
Adet / Piece	2																																						
Kod / Code	LTS-1Y																																						
Adet / Piece	1																																						
Kod / Code	LTS-1Y																																						
Adet / Piece	1																																						
 <p>Teker Sabitleyici Plastik Wheel Fixing Plastic</p> <table border="1"> <tr> <td>Kod / Code</td> <td>LTS-1Y</td> </tr> <tr> <td>Adet / Piece</td> <td>8</td> </tr> </table>	Kod / Code	LTS-1Y	Adet / Piece	8	 <p>Sabit Köşe Takoza Alt Glass Corner Wedge Bottom</p> <table border="1"> <tr> <td>Kod / Code</td> <td>LTS-8</td> </tr> <tr> <td>Adet / Piece</td> <td>2</td> </tr> </table>	Kod / Code	LTS-8	Adet / Piece	2	 <p>Plastik Tapa Plastic Plug</p> <table border="1"> <tr> <td>Kod / Code</td> <td>LTS-8</td> </tr> <tr> <td>Adet / Piece</td> <td>20</td> </tr> </table>	Kod / Code	LTS-8	Adet / Piece	20	 <p>Alt Baza Plastiği Base And Side Profile</p> <table border="1"> <tr> <td>Kod / Code</td> <td>LTS-8</td> </tr> <tr> <td>Adet / Piece</td> <td>2</td> </tr> </table>	Kod / Code	LTS-8	Adet / Piece	2	 <p>Zincir Aktarım Plastiği Chain Transfer Plastic</p> <table border="1"> <tr> <td>Kod / Code</td> <td>LTS-8</td> </tr> <tr> <td>Adet / Piece</td> <td>2</td> </tr> </table>	Kod / Code	LTS-8	Adet / Piece	2	 <p>Boru Başı Pipe Head</p> <table border="1"> <tr> <td>Kod / Code</td> <td>LTS-8</td> </tr> <tr> <td>Adet / Piece</td> <td>1</td> </tr> </table>	Kod / Code	LTS-8	Adet / Piece	1	 <p>Profil Kapak Plastiği Profile Cover Plastic</p> <table border="1"> <tr> <td>Kod / Code</td> <td>LTS-8</td> </tr> <tr> <td>Adet / Piece</td> <td>6</td> </tr> </table>	Kod / Code	LTS-8	Adet / Piece	6	 <p>Açılır Cam Sabitleme Plastiği Glass Fixing Plastic</p> <table border="1"> <tr> <td>Kod / Code</td> <td>LTS-8</td> </tr> <tr> <td>Adet / Piece</td> <td>2</td> </tr> </table>	Kod / Code	LTS-8	Adet / Piece	2
Kod / Code	LTS-1Y																																						
Adet / Piece	8																																						
Kod / Code	LTS-8																																						
Adet / Piece	2																																						
Kod / Code	LTS-8																																						
Adet / Piece	20																																						
Kod / Code	LTS-8																																						
Adet / Piece	2																																						
Kod / Code	LTS-8																																						
Adet / Piece	2																																						
Kod / Code	LTS-8																																						
Adet / Piece	1																																						
Kod / Code	LTS-8																																						
Adet / Piece	6																																						
Kod / Code	LTS-8																																						
Adet / Piece	2																																						
 <p>Rulmanlı Teker Bearing Wheel</p> <table border="1"> <tr> <td>Kod / Code</td> <td>LTS-1Y</td> </tr> <tr> <td>Adet / Piece</td> <td>16</td> </tr> </table>	Kod / Code	LTS-1Y	Adet / Piece	16	 <p>Boyanabilir Can be Painted</p>  <p>Tüp Motor Kapağı Tube Motor Cover</p> <table border="1"> <tr> <td>Kod / Code</td> <td>LTS-1Y</td> </tr> <tr> <td>Adet / Piece</td> <td>2</td> </tr> </table>	Kod / Code	LTS-1Y	Adet / Piece	2	 <p>Rulman Yatağı Bearing Fastening</p> <table border="1"> <tr> <td>Kod / Code</td> <td>LTS-1Y</td> </tr> <tr> <td>Adet / Piece</td> <td>1</td> </tr> </table>	Kod / Code	LTS-1Y	Adet / Piece	1	 <p>Rulman Kelepçesi Bearing Clamp</p> <table border="1"> <tr> <td>Kod / Code</td> <td>LTS-1Y</td> </tr> <tr> <td>Adet / Piece</td> <td>1</td> </tr> </table>	Kod / Code	LTS-1Y	Adet / Piece	1	 <p>Motor Kutusu Kızağı Motor Box Sled</p> <table border="1"> <tr> <td>Kod / Code</td> <td>LTS-1Y</td> </tr> <tr> <td>Adet / Piece</td> <td>2</td> </tr> </table>	Kod / Code	LTS-1Y	Adet / Piece	2	 <p>Zincir Chain</p> <table border="1"> <tr> <td>Kod / Code</td> <td>GYT-19</td> </tr> <tr> <td>Adet / Piece</td> <td>5 meters</td> </tr> </table>	Kod / Code	GYT-19	Adet / Piece	5 meters	 <p>Lotus Dişli Lotus Gear</p> <table border="1"> <tr> <td>Kod / Code</td> <td>LTS-6</td> </tr> <tr> <td>Adet / Piece</td> <td>2</td> </tr> </table>	Kod / Code	LTS-6	Adet / Piece	2	 <p>Teker Sabitleme Vidası Wheel Fixing Screw</p> <table border="1"> <tr> <td>Kod / Code</td> <td>LTS-1Y</td> </tr> <tr> <td>Adet / Piece</td> <td>16</td> </tr> </table>	Kod / Code	LTS-1Y	Adet / Piece	16
Kod / Code	LTS-1Y																																						
Adet / Piece	16																																						
Kod / Code	LTS-1Y																																						
Adet / Piece	2																																						
Kod / Code	LTS-1Y																																						
Adet / Piece	1																																						
Kod / Code	LTS-1Y																																						
Adet / Piece	1																																						
Kod / Code	LTS-1Y																																						
Adet / Piece	2																																						
Kod / Code	GYT-19																																						
Adet / Piece	5 meters																																						
Kod / Code	LTS-6																																						
Adet / Piece	2																																						
Kod / Code	LTS-1Y																																						
Adet / Piece	16																																						
 <p>Lotus İspanyolet Lotus Espagnolette</p> <table border="1"> <tr> <td>Kod / Code</td> <td>LTS-1Y</td> </tr> <tr> <td>Adet / Piece</td> <td>2</td> </tr> </table>	Kod / Code	LTS-1Y	Adet / Piece	2	 <p>Zincir Askı Aparatı Chain Hanger Apparatus</p> <table border="1"> <tr> <td>Kod / Code</td> <td>LTS-1Y</td> </tr> <tr> <td>Adet / Piece</td> <td>2</td> </tr> </table>	Kod / Code	LTS-1Y	Adet / Piece	2	 <p>M4 Fiberli Somun M4 Fiber Nut</p> <table border="1"> <tr> <td>Kod / Code</td> <td>LTS-1Y</td> </tr> <tr> <td>Adet / Piece</td> <td>8</td> </tr> </table>	Kod / Code	LTS-1Y	Adet / Piece	8	 <p>Lotus Kol Lotus Arm</p> <table border="1"> <tr> <td>Kod / Code</td> <td>LTS-5</td> </tr> <tr> <td>Adet / Piece</td> <td>2</td> </tr> </table>	Kod / Code	LTS-5	Adet / Piece	2	 <p>Vasistas Makas Vasistas Scissors</p> <table border="1"> <tr> <td>Kod / Code</td> <td>LTS-1Y</td> </tr> <tr> <td>Adet / Piece</td> <td>2</td> </tr> </table>	Kod / Code	LTS-1Y	Adet / Piece	2	 <p>6001 Rulman 6001 Bearing</p> <table border="1"> <tr> <td>Kod / Code</td> <td>LTS-1Y</td> </tr> <tr> <td>Adet / Piece</td> <td>1</td> </tr> </table>	Kod / Code	LTS-1Y	Adet / Piece	1	 <p>Lotus Vida Seti Lotus Bolt Set</p> <table border="1"> <tr> <td>Kod / Code</td> <td>LTS-1Y</td> </tr> <tr> <td>Adet / Piece</td> <td>1</td> </tr> </table>	Kod / Code	LTS-1Y	Adet / Piece	1					
Kod / Code	LTS-1Y																																						
Adet / Piece	2																																						
Kod / Code	LTS-1Y																																						
Adet / Piece	2																																						
Kod / Code	LTS-1Y																																						
Adet / Piece	8																																						
Kod / Code	LTS-5																																						
Adet / Piece	2																																						
Kod / Code	LTS-1Y																																						
Adet / Piece	2																																						
Kod / Code	LTS-1Y																																						
Adet / Piece	1																																						
Kod / Code	LTS-1Y																																						
Adet / Piece	1																																						



Lotus Zincirli Aksesuar Seti Yeni

Lotus Chain Accessories New Set



Motor Kutusu Çontası
Engine Box Seal

Kod / Code	GYT-28
Adet / Piece	75 Meters

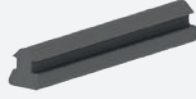

Kenetli Profil Çontası
Clamped Profile Bolt

Kod / Code	GYT-27
Adet / Piece	300 meters



67x800 Kıl Fitol
67x800 Bristle Wick

Kod / Code	GYT-29
Adet / Piece	250 meters



ERS 120 NM Elektronik Motor
ERS 120 NM Electronic Motor

Kod / Code	ERS-120NM-ELK
Adet / Piece	1



ERS Kumanda
ERS Control

Kod / Code	ERS-809
Adet / Piece	1



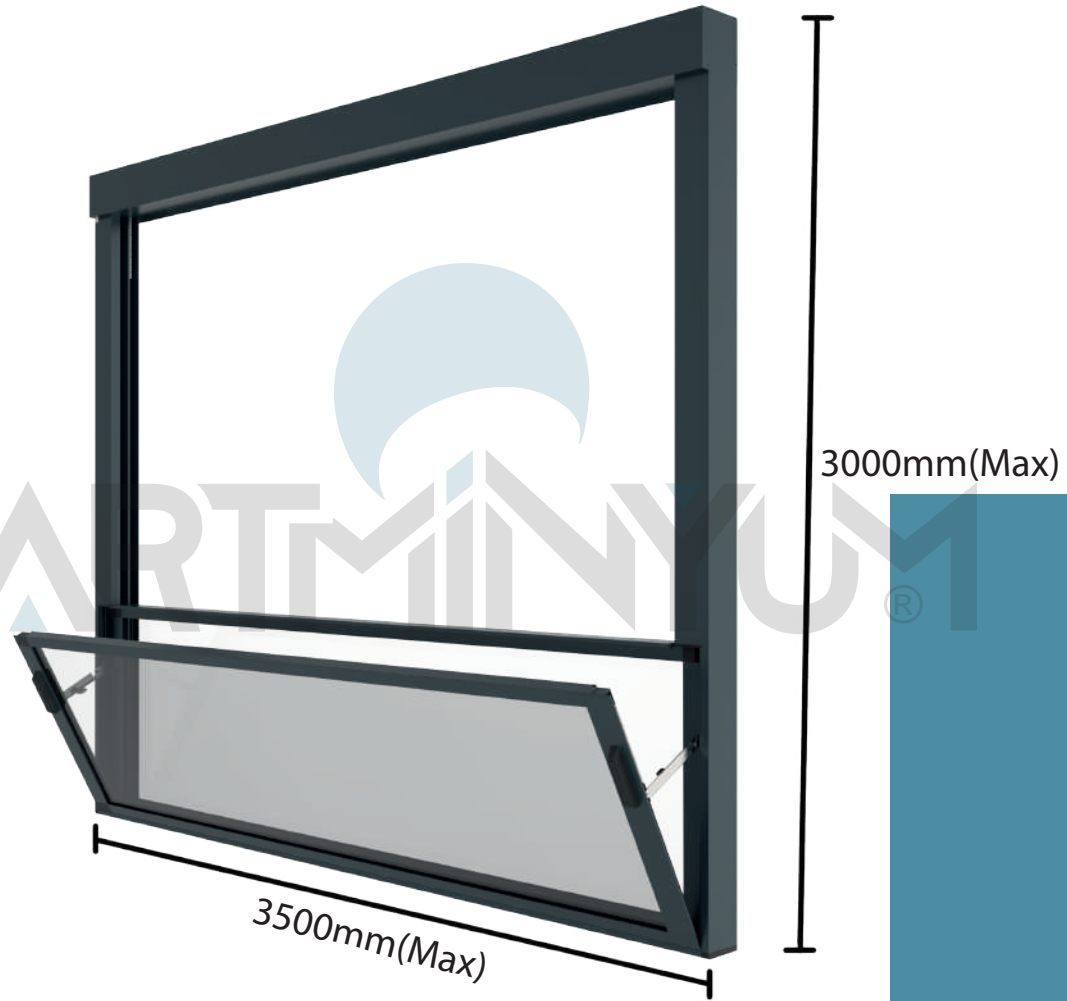

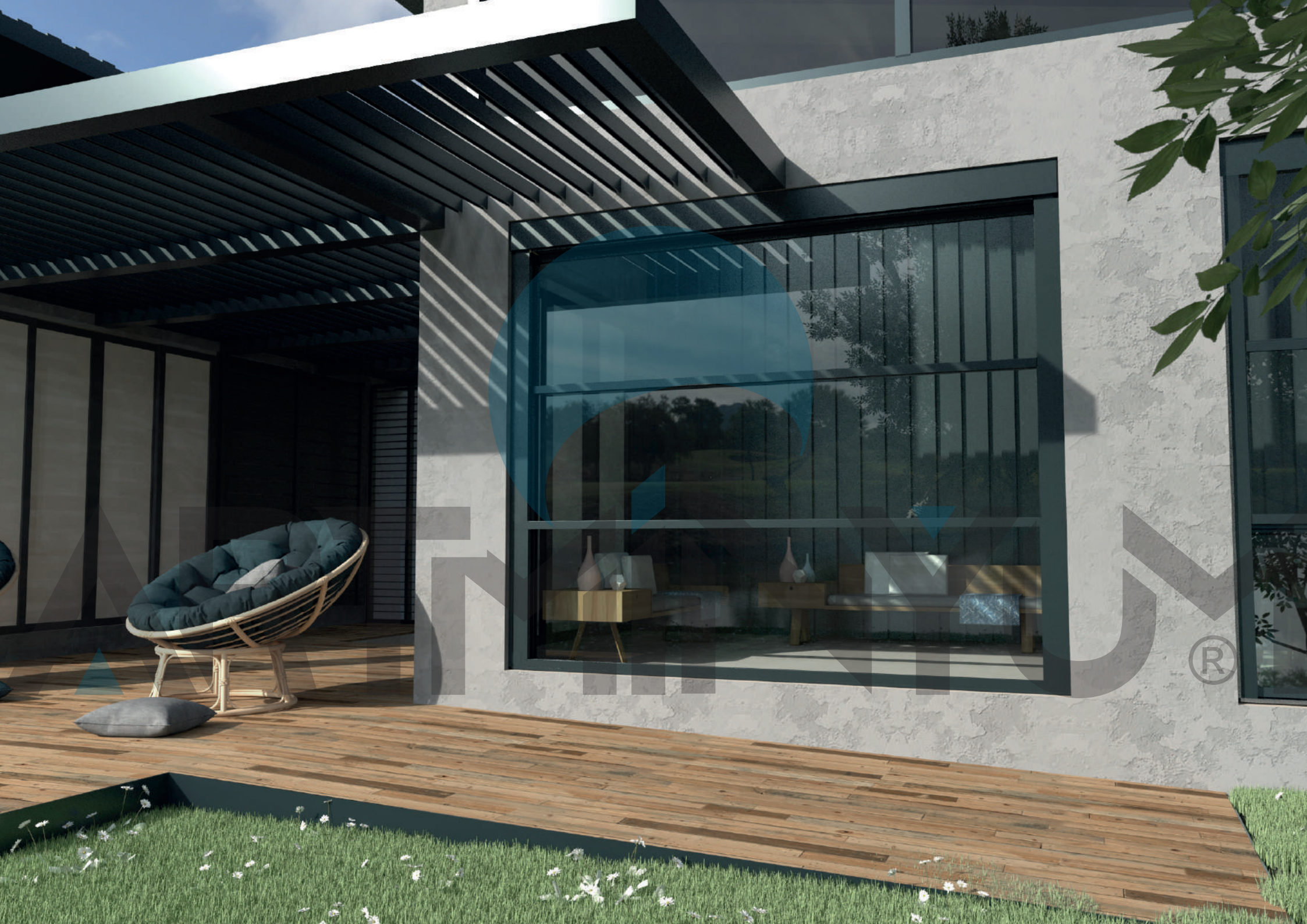

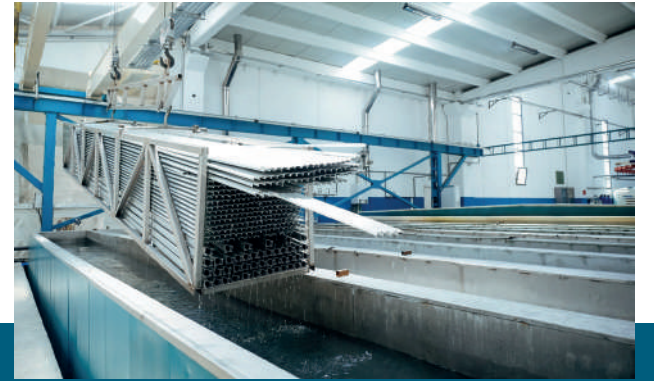
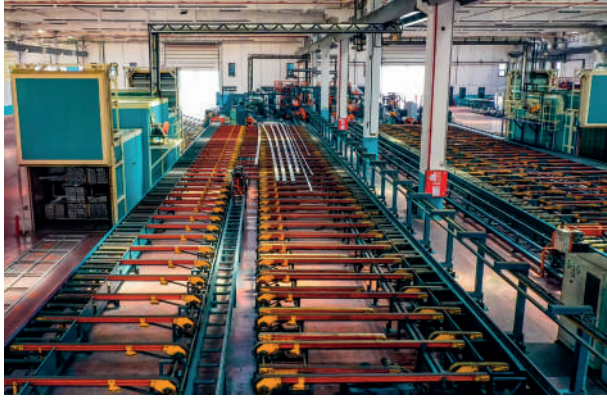

Biz Kimiz ?

Üstün kaliteli alüminyum profil üretimini her geçen gün artan standartlarla devam ettiren Kenan Metal A.Ş. ülkemizin önde gelen alüminyum fabrikalarından biridir. Mutlak müşteri ve çalışan memnuniyeti prensibiyle üretim yapan Kenan Metal A.Ş., tente pergola, inşaat ve özel profiller gibi farklı sektörlerin mevcut ve gelecekteki beklentilerini karşılayan, çevreyle dost üretim sistemlerini benimseyen, küresel etkileşimleri yakından takip ederek sürekli yenilenen, çağdaş bir vizyonla gelişiyor. Ürün-kalite çitasının sürekli yükseltilmesi, ürün yelpazesinin geliştirilmesi, yeni ürünlerin tasarımı, kullanım alanlarının artırılması için sürekli olarak çalışan Ar-Ge bölümüyle göz dolduran Kenan Metal A.Ş., kalitesi güvenilirliği, kullandığı teknoloji ve özel çözümler üretme gücüyle pazar payını sürekli genişletiyor.

Kenan Metal A.Ş., alüminyum bazlı ürünlerin kalitelerini arttırarak ve kullanım alalarını yaygınlaştırarak doğal ve estetik mekanların yaratılmasına da öncülük ediyor. Her yapı için kendine özgü üstün nitelikli ve ileri teknoloji gerektiren çağdaş çözümler sunan Kenan Metal A.Ş., esnek yaklaşımları üstün hizmet kalitesi ve fiyat-kalite dengesiyle küresel pazarda söz sahibi bir kurum olma yolunda emin adımlarla ilerliyor.

Who Are We?

Kenan Metal is one of the leading aluminum factories of our country which continues to produce high quality aluminum profiles with increasing standards each passing day. Kenan Metal which makes production with absolute customer and employee satisfaction principle, develops with a modern vision that meets current and future expectations of different sectors such as awning pergola, construction and special profiles, adopts environmentally friendly production systems, renews itself constantly by following global interactions closely.

Kenan Metal which makes a strong impression with its R&D department working constantly for raising product-quality level, improving product range, designing new products, increasing usage areas, expands its market share constantly with its quality, credibility technology used and power to produce special solutions

Kenan Metal is also leading creation of natural and aesthetic spaces by increasing quality of aluminum-based products and expanding usage areas. Kenan Metal which offers its unique, superior and modern solutions requiring advanced technology for every structure, is moving confidently on its way to become a promising company in global market with its flexible approaches, superior service quality and price-quality balance.



KENAN METAL®





kenanmetal.com | info@kenanmetal.com | +90 212 485 60 35

Genel Merkez : İosb Mh. Atatürk Blv. Mahmut Torun İş Merkezi No: 54 Kat: 1 34490 İkitelli Osb / Başakşehir / İstanbul
Fabrika : Velimeşe Mahallesi, Kandil Caddesi, 329 Sokak, Dış Kapı No:7 Ergene / Tekirdağ

